

TFT COLOR LCD MODULE

NL128102AC28-01F

**46 cm (18.1 inches), 1280 × 1024 pixels, full-color,
ultrawide viewing angle, multiscan function
built-in CRT interface board**

DESCRIPTION

The NL128102AC28-01F is a TFT (thin film transistor) active-matrix color liquid crystal display (LCD) comprising an amorphous silicon TFT attached to each signal electrode, a driving circuit, a CRT interface board, and a backlight. NL128102AC28-01F has a built-in backlight with an inverter.

The 46 cm (18.1 inch) diagonal display area contains 1280 × 1024 pixels and can display fullcolor (more than 16 million colors simultaneously). Also, it has a wide viewing angle and multiscan function. Therefore, we call this module Super Fine TFT.

The NL128102AC28-01F is the model with the CRT interface board which is mounted on NL128102AC28-01E.

FEATURES

- Ultrawide viewing angle (with lateral electric field)
- CRT interface board
 - Auto recognition of input signal (Analog RGB signals, sync on green, synchronous signals (Hsync, Vsync, composite))
 - Digital control: e.g., brightness, display position
 - Free supply voltage sequence
 - Corresponds to DDC1 and DDC2B
 - Corresponds to VESA, DPMS
- Multiscan functions: e.g., SXGA, XGA, SVGA, VGA, VGA-TEXT, PC-9801, MAC SUN
- Incorporated direct type: backlight (eight lamps in the backlight unit, inverter)
- Backlight unit replacable (Part No. :181LHS03)
- On-screen display

Application with the OSD function might conflict with patents in Europe and/or the U.S.A.

If you apply the OSD function, please do so in accordance with the patent regulations of your location.

VESA : Video Electronics Standards Association

DDC1: Display Data Channel 1

DPMS: Display Power Management Signaling

DDC2B: Display Data Channel 2B

APPLICATIONS

- Desktop PCs,
Engineering workstations
- Display terminals for
control systems
- Monitors for process controllers



Please confirm with the delivery specification before starting to design your system.

The information in this document is subject to change without notice.

STRUCTURE AND FUNCTION

A color TFT (thin film transistor) LCD module is comprised of a TFT liquid crystal panel structure, LSIs for driving the TFT array, and a backlight assembly. The TFT panel structure is created by sandwiching liquid crystal material in the narrow gap between a TFT array glass substrate and a color filter glass substrate. After the driver LSIs are connected to the panel, the backlight assembly is attached to the back side of the panel.

RGB (red, green, blue) data signals from a source system are modulated into a form suitable for active-matrix addressing by the onboard signal processor and sent to the driver LSIs, which in turn address the individual TFT cells.

Acting as an electro-optical switch, each TFT cell regulates light transmission from the backlight assembly when activated by the data source. By regulating the amount of light passing through the array of red, green, and blue dots, color images are created with clarity.

OUTLINE OF CHARACTERISTICS (at room temperature)

Display area	359.04 (H) × 287.232 (V) mm
Drive system	a-Si TFT active matrix
Display colors	Fullcolor
Number of pixels	1280 × 1024 pixels
Pixel arrangement	RGB vertical stripe
Pixel pitch	0.2805 (H) × 0.2805 (V) mm
Module size	424.0 (H) × 337.0 (V) × 41.0 (D) mm (TYP.)
Weight	2130 g (TYP.)
Contrast ratio	300 : 1 (TYP.)
Viewing angle (more than the contrast ratio of 10 : 1)	Horizontal: 85° (TYP., left side, right side) Vertical: 85° (TYP., up side, down side)
Design viewing direction	Optimum grayscale ($\gamma = 2.2$): perpendicular
Color gamut	60% (TYP., at center, to NTSC)
Response time	40 ms (TYP.), "black" (0%) to "white" (90%)
Luminance	200 cd/m ² (TYP.)
Signal system	Analog RGB signals, synchronous signals (Hsync and Vsync or composite), digital data
Supply voltages	12 V (Logic/LCD driving), 12 V (Backlight)
Backlight	Direct type: eight cold cathode fluorescent lamps with an inverter <ul style="list-style-type: none"> • Inverter: Part No. 181PW031 • Backlight unit: part No. 181LHS03
Power consumption	43.2 W (TYP.)

BLOCK DIAGRAM

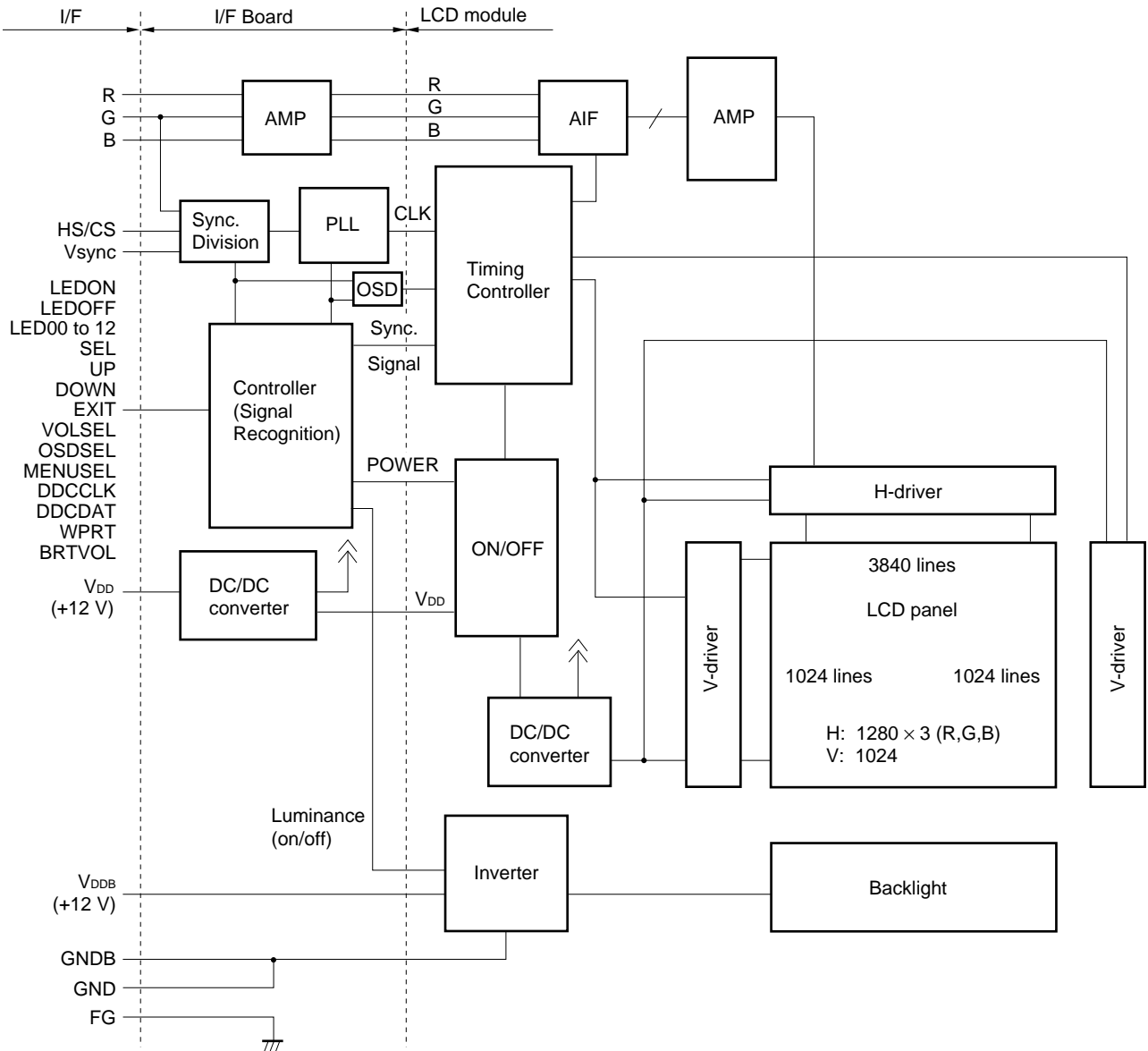

HS : Hsync
 CS : Composite synchronous signal
Note FG (Frame Ground) is not connected to GND nor G_{NDB}. GND is connected to G_{NDB}.

GENERAL SPECIFICATIONS

Item	Specification	Unit
Module size	424.0 ± 1.0 (H) × 337.0 ± 1.0 (V) × 42.0 (MAX.) (D)	mm
Display area	359.04 (H) × 287.232 (V)	mm
Number of dots	1280 × 3 (H) × 1024 (V)	dot
Dot pitch	0.0935 (H) × 0.2805 (V)	mm
Pixel pitch	0.2805 (H) × 0.2805 (V)	mm
Pixel arrangement	RGB (red, green, blue) vertical stripe	–
Display colors	full color	color
Weight	2130 (TYP.) 2230 (MAX.)	g

ABSOLUTE MAXIMUM RATINGS

Parameter	Symbol	Rating	Unit	Remarks
Supply voltage	V _{DD}	–0.3 to +14	V	T _a = 25°C
	V _{DDB}	–0.3 to +14	V	
Logic input voltage	V _{IN1}	–0.3 to +5.5	V	T _a = 25°C V _{DD} = 12 V
R,G,B input voltage	V _{IN2}	–6.0 to +6.0	V	
CLK input voltage	V _{IN3}	–7.0 to +7.0	V	
Storage temp.	T _{ST}	–20 to + 60	°C	–
Operating temp.	T _{OP}	0 to +55	°C	Module surface Note
Relative humidity (RH)	≤ 95%		T _a ≤ 40°C	No condensation
	≤ 85%		40 < T _a ≤ 50°C	
	≤ 70%		50 < T _a ≤ 55°C	
Absolute humidity	Absolute humidity (g/m ³) shall not exceed T _a = 55°C, RH = 70% level.		T _a > 50°C	

Note Measured at the LCD panel

ELECTRICAL CHARACTERISTICS

(1) Logic, LCD Driving, Backlight

T_a = 25°C

Parameter	Symbol	MIN.	TYP.	MAX.	Unit	Remarks
Supply voltage	V _{DDB}	11.4	12.0	12.6	V	for backlight
	V _{DD}	11.4	12.0	12.6	V	for logic and LCD driving
Logic input Low voltage	V _{IL}	0	–	0.8	V	HS/CS, Vsync, SEL, UP, DOWN, EXIT, VOLSEL, DDCDAT, DDCCLK, OSDSEL, WPRT, MENUSEL
Logic input High voltage	V _{IH}	2.2	–	5.25	V	
Logic output Low voltage	V _{OL}	–	–	0.4	V	LED00/01/02/10/11/12
Logic output High voltage	V _{OH}	2.4	–	–	V	
Logic input Low current	I _{IL}	–1	–	–	μA	HS/CS, Vsync
Logic input High current	I _{IH}	–	–	1	μA	
Supply current	I _{DD}	–	1050 Note	1500	mA	V _{DD} = 12.0 V
		–	45 Note	65	mA	Power-saving mode, V _{DD} = 12.0 V
	I _{DDB}	–	2550	3500	mA	V _{DDB} = 12.0 V (Max. luminance)
		–	1	10	mA	Power-saving mode, V _{DDB} = 12.0 V

Note Checker flag pattern (in EIAJ ED-2522)

(2) Video Signal (R,G,B) Input

T_a = 25°C

Item	MIN.	TYP.	MAX.	Unit	Remarks
Maximum amplitude (black - white)	0 (black)	0.7 (white)	*A	V p-p	Need to adjust contrast if the input is more than 0.7 Vp-p
DC input level (black)	–0.5	–	+2.5	V	–
Sync. level	0.2	0.3	*B	V p-p	G terminal (Sync. On Green)
*A + *B	–	–	1.1	V p-p	–

(3) Input Equivalent Circuit

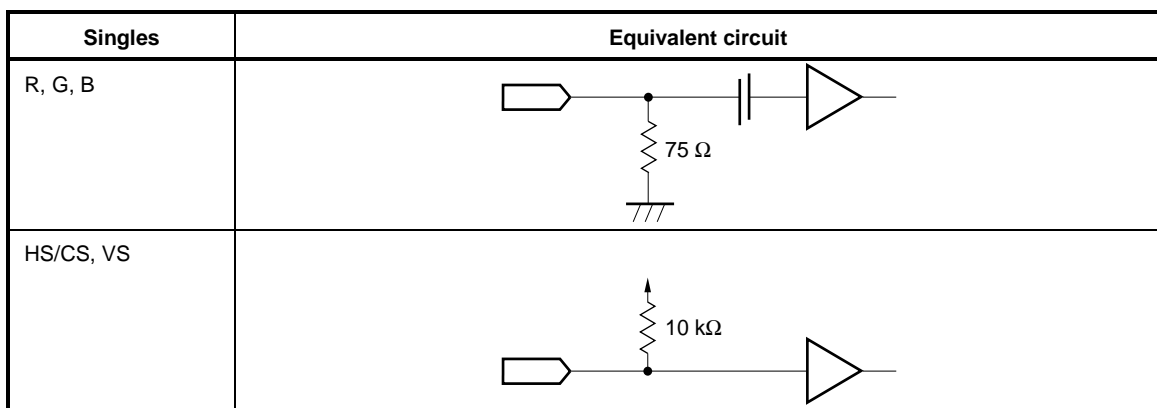

POWER SUPPLY DESIGN

- (1) 12 V for backlight should be started up with in 800ms otherwise, the protection circuit makes the backlight turns off.
- (2) Please note that the supply voltage must not be applied while the control signals (SEL, UP, DOWN, EXIT) are connected to GND. Otherwise, the module may malfunction.
- (3) If the power supply voltage is applied while UP and DOWN are connected to GND, the input control signals become ineffective. To reset this mode, turn off the power once and then turn on the power while UP and DOWN are connected to GND. The mode will then be released.
- (4) Inverter current wave
The inverter current wave is as follows.

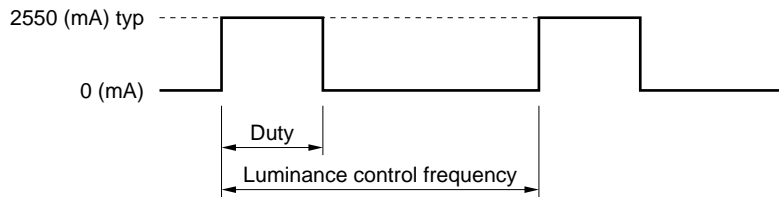

Maximum luminance control: 100%
 Minimum luminance control: 20% (Duty)
 $\text{Luminance control frequency} \approx \text{Input Vsync frequency} \times K$
 Input Vsync frequency \leq 75 Hz: $K = 4.6$
 Input Vsync frequency $>$ 75 Hz: $K = 3.6$
 Please set up like above diagram.

(5) Ripple of supply voltage

	V _{DD} (for logic and LCD driver)	V _{DDB} (for backlight)
Acceptable range	≤ 100 mV p-p	≤ 200 mV p-p

Remark The acceptable range of ripple voltage includes spike noise.

Example of the power supply connection

a) Separate the power supply

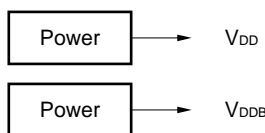

b) Put in the filter

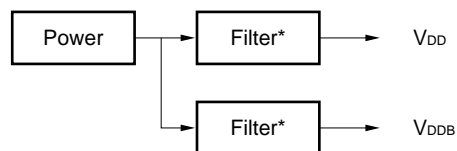

[Filter* (Reference value)]
 $L = 10 \mu\text{H to } 100 \mu\text{H}$
 $C = 10 \mu\text{F to } 100 \mu\text{F}$

(6) Fuse

Supply voltage	Part No.	Supplier	Ratings	Remarks
V _{DD}	CCF1NTE3, 15A	KOA	3.15 A	-
V _{DDDB}	<1> R429005	LITTLE FUSE	5 A	<1> or <2> is used
	<2> MMC75A	SOC	5 A	

Remarks The fuses shown in the above table are installed in power-input terminals of LCD module.
Please design your power supply with a capacity of the more than the double of the fuse rating for safety of the module. In case where the power-supply capacity is under the double of the fuse rating, please note that the sufficient evaluation about the safety in case of short circuit is indispensable.

INTERFACE PIN CONNECTION

(1) INTERFACE CONNECTORS

CN101

Part No.: MRF03-6R-SMT
 Adaptable socket: MRF03-6P-1.27 (For cable type) or MRF03-6PR-SMT (For board to board type)
 Supplier: HIROSE ELECTRIC CO., LTD. (coaxial type)
 Coaxial cable: UL20537PF75VLAS
 Supplier: HITACHI CO.,LTD.

Note A coaxial cable shield should be connected with GND.

Pin No.	Symbol	Pin No.	Symbol
1	B	4	V _{sync}
2	G	5	HS/CS
3	R	6 ▼	N.C.

Figure from socket view

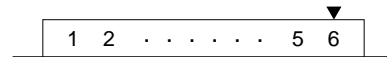

CN102

Part No.: IL-Z-4PL-SMTY
 Adaptable socket: IL-Z-4S-S125C3
 Supplier: Japan Aviation Electronics Industry Limited (JAE)

Pin No.	Symbol	Pin No.	Symbol
1	DDCCLK	3	MENUSEL
2	DDCDAT	4	GND

Figure from socket view

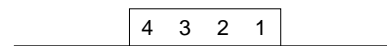

CN103

Part No.: DF14A-25P-1.25H
 Adaptable socket: DF14-25S-1.25C
 Supplier: HIROSE ELECTRIC CO., LTD.

Pin No.	Symbol	Pin No.	Symbol
1	LEDON	14	EXIT
2	LEDOFF	15	GND
3	GND	16	BRTVOL
4	LED00	17	GND
5	LED01	18	VOLSEL
6	LED02	19	OSDSEL
7	LED10	20	WPRT
8	LED11	21	N.C.
9	LED12	22	N.C.
10	GND	23	GND
11	SEL	24	N.C.
12	UP	25	N.C.
13	DOWN		

Figure from socket view

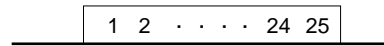

Note N.C. (No connection) must be open.

CN104

Part No.: IL-Z-8PL-SMTY
 Adaptable socket: IL-Z-8S-S125C3
 Supplier: Japan Aviation Electronics Industry Limited (JAE)

Pin No.	Symbol	Pin No.	Symbol
1	V _{DD}	5	GND
2	V _{DD}	6	GND
3	V _{DD}	7	GND
4	V _{DD}	8	GND

Figure from socket view

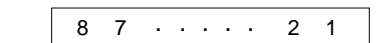

CN201

Part No.: DF3-8P-2H
 Adaptable socket: DF3-8S-2C
 Supplier: HIROSE ELECTRIC CO., LTD.

Pin No.	Symbol	Pin No.	Symbol
1	GNDB	5	V _{DD} B
2	GNDB	6	V _{DD} B
3	GNDB	7	V _{DD} B
4	GNDB	8	V _{DD} B

Figure from socket view

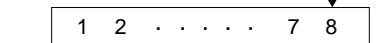

<Connector location>

Rear view

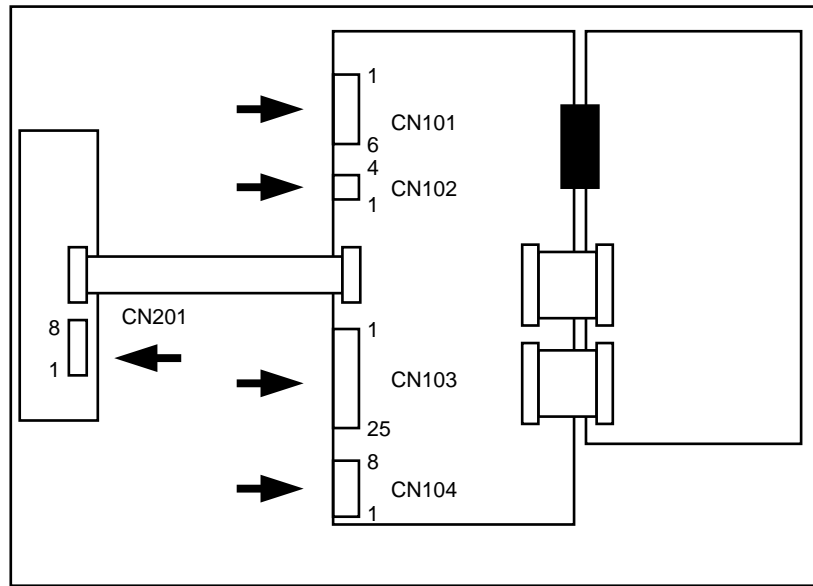

(2) PIN FUNCTION

Symbol	I/O	Logic	Description
HS/CS	Input	Negative	Horizontal synchronous signal input or composite synchronous signal input (TTL level) , positive/negative auto recognition
Vsync	Input	Negative	Vertical synchronous signal input (TTL level), positive/negative auto recognition, clock input for DDC1
R	Input	-	Red video signal input (0.7 Vp-p, 75 Ω)
G	Input	-	Green video signal input (0.7 Vp-p, 75 Ω)
B	Input	-	Blue video signal input (0.7 Vp-p, 75 Ω)
SEL	Input	Negative	Control function select signal (TTL level) SEL is pulled up in the module. Details of the functions are mentioned in CONTROL FUNCTIONS , Page 14. "H" or "open"; SEL off, "L"; SEL on
UP	Input	Negative	Control signal (TTL level) The signal increases the value of the functions selected. UP is pulled up in the module. "H" or "open"; UP off, "L"; UP on
DOWN	Input	Negative	Control signal (TTL level) The signal decreases the value of the functions selected. DOWN is pulled up in the module. "H" or "open"; DOWN off, "L"; Down on
EXIT	Input	Negative	Control signal (TTL level) The signal initializes the selected function. EXIT is pulled up in the module. "H" or "open"; EXIT off, "L"; EXIT on

Symbol	I/O	Logic	Description
OSDSEL	Input	–	Display select signal (TTL level) OSDSEL is pulled up in the module. “H or open”: OSD display off (light on LED) “L”: OSD display on (light off LED) Details of the functions are mentioned in FUNCTION DISPLAY SELECT , Page 11.
MENUSEL	Input	–	OSD design select signal MENUSEL is pulled up in the module. “H or open”: OSD display No.2 “L”: OSD display No.1 (Transparent background) Detail of the functions are mentioned in OSD DESIGN SELECT , Page 11.
BRTVOL	Input	–	Luminance control pin Detail of the functions are mentioned in LUMINANCE CONTROL SELECT , Page 11.
VOLSEL	Input	–	Luminance control select signal VOLSEL is pulled up in the module. Details of the functions are mentioned in LUMINANCE CONTROL SELECT , Page 11.
DDCCLK	Input	Positive	CLK for DDC2B
DDCDAT	Input/ Output	Positive	Data for DDC1/2B Read/write
WPRT	Input	Positive	Select signal for DDC “H” or “Open”; Reading mode, “L”; Writing mode
LEDON	Output	Positive	Indicator for LED power on “H”; LED select, “L”; Other status
LEDOFF	Output	Positive	Indicator for power save mode “H”; power save mode select, “L”; Other status
LED00	Output	Positive	See details of Page 12, EQUIVALENT CIRCUIT FOR LEDS and Page 14, CONTROL FUNCTIONS .
LED01	Output	Positive	
LED02	Output	Positive	
LED10	Output	Negative	
LED11	Output	Negative	
LED12	Output	Negative	
V _{DD}	–	–	Power supply for Logic and LCD driving +12 V (±5 %)
V _{DDB}	–	–	Power supply for backlight +12 V (±5 %) ^{Note 1}
GND ^{Note 2}	–	–	GND for logic and LCD driving (V _{DD})
GNDB ^{Note 2}	–	–	Ground for backlight power supply (V _{DDB})

Notes 1: 12V for backlight should be started up with in 800 ms, otherwise, the protection circuit makes the backlight turn off.

2: GND is connected to GNDB. FG (Frame Ground) is not connected to GND and GNDB.

(3) LUMINANCE CONTROL SELECT

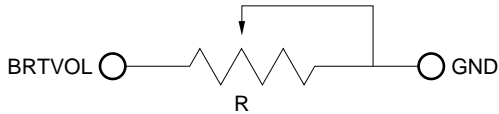
Form	PWM adjust	Volume resister adjust
How to adjust	VOLSEL = "L"	VOLSEL = "Open"
	See Page 14, CONTROL FUNCTIONS.	<p>The variable resistor for luminance control should be 10 kΩ type, and zero point of the resistor corresponds to the minimum of luminance.</p>  <p>Maximum luminance (100%): R = 10 KΩ Minimum luminance (30%): R = 0 Ω Mating variable resistor: 10 KΩ ±5%, B curve, 1/10 W</p>

Note The status of VOLSEL is valid when the power is switched on.

(4) FUNCTION DISPLAY SELECT

Form	OSD Display	LED Display
How to adjust	OSDSEL = "L"	OSDSEL = "Open"
	See Page 14, CONTROL FUNCTIONS.	See Example of LED circuit. (Next page)

Note The status of OSDSEL is valid when the power is switched on.

(5) OSD DESIGN SELECT

Form	OSD display No. 1	OSD display No. 2
How to adjust	MENUSEL = "L"	MENUSEL = "Open"
	See Page 14, CONTROL FUNCTIONS. (OSD background is transparent.)	See Page 14, CONTROL FUNCTIONS.

Note The status of MENUSEL is valid when the power is switched on.

(6) EQUIVALENT CIRCUIT FOR LEDS

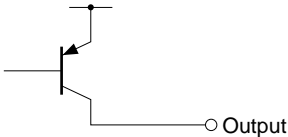
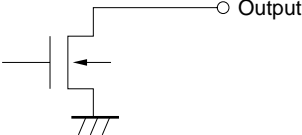
Symbol	I/O	Equivalent circuit
LEDON LEDOFF LED00 LED01 LED02	Output	RN2306 (Toshiba) or equivalent 
LED10 LED11 LED12	Output	N-ch Open Drain Output 

Recommendation circuit diagram

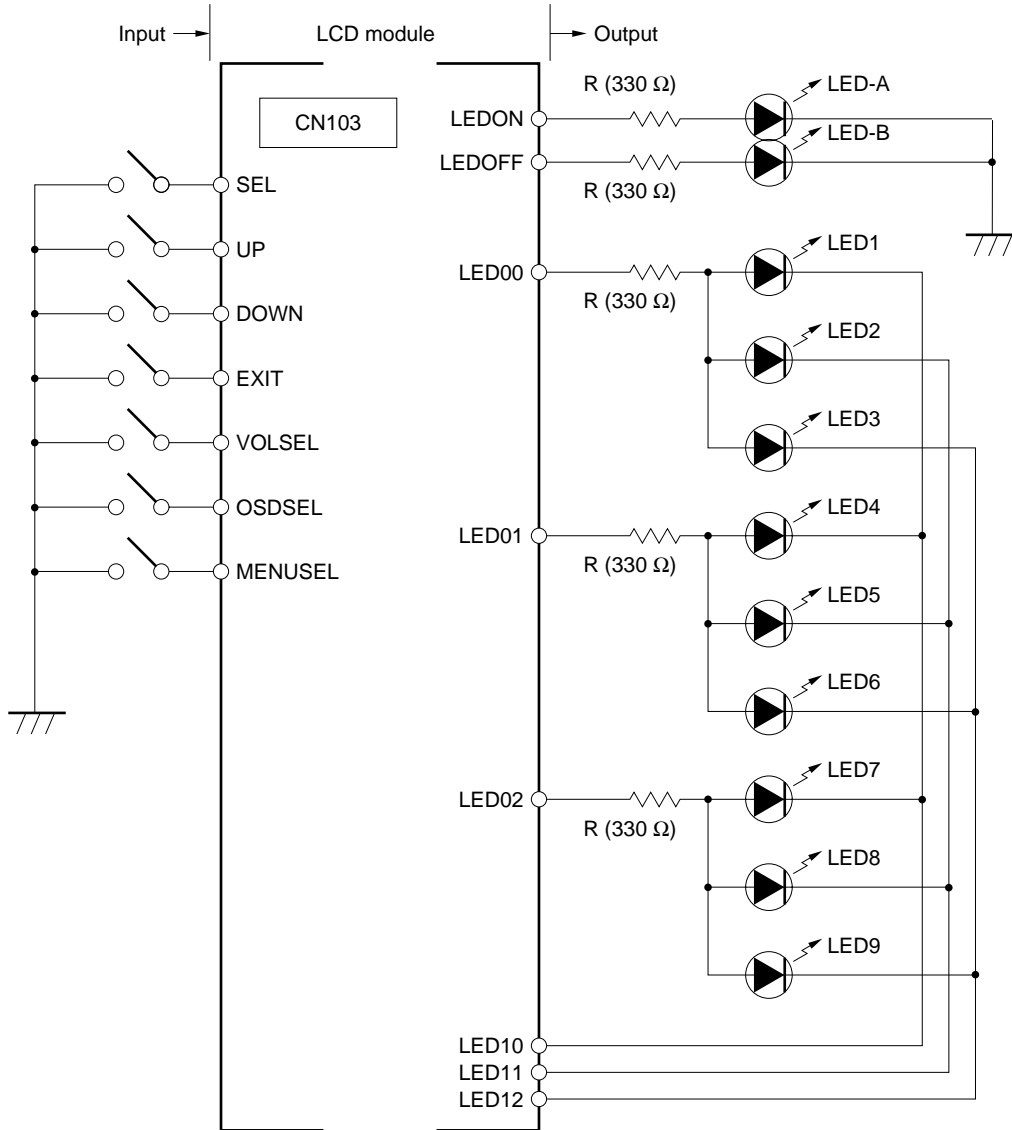

<LED status>

- LED-A: Power on
- LED-B: Power-save mode
- LED1: Brightness
- LED2: Contrast
- LED3: Horizontal display period
- LED4: CLK delay
- LED5: Vertical position
- LED6: Horizontal position
- LED7: Reserve
- LED8: All reset
- LED9: Reserve

INPUT SYNCHRONOUS SIGNALS

This module is corresponding to the synchronous signals below.

Auto recognition mode	Synchronous signals		
	HS/CS	Vsync	Sync. On Green
Separate synchronous signal mode (Hsync, Vsync)	Input	Input	Input or no input
Composite synchronous mode	Input	No input	Input or no input
Sync. on Green mode	No input	No input	Input
Power-saving mode	No input	No input	Input

Note Power-saving mode corresponds to VESA DPMA.

CONTROL FUNCTIONS

Function Items

(1) The function for OSD or LED

- 1. Brightness: Brightness of backlight control
- 2. Contrast: White-level of video signal control
- 3. Horizontal display period: Horizontal display period adjust
- 4. CLK delay: CLK-phase adjust
- 5. Vertical position: Vertical position adjust
- 6. Horizontal position: Horizontal position adjust
- 7. All Reset: Reset to factory-default value

(2) The function for OSD

- 1. Sub Brightness: Brightness with each video signal Control
- 2. Sub Contrast: White-level with each video signal Control
- 3. Video signal information: Display multi-scan function, Hsync and Vsync frequency

Each selected value is memorized into LCD memory after SEL signal input or time out. The memorized values are not affected even if the power is turned off. But the selected value is not memorized in case that a selected mode is changed another one before time out or power is turned off before time out.

Regarding the brightness, the brightness value can not be memorized while the variable volume resistor is selected.

This function does not work during the power-saving mode.

INDICATOR OF THE FUNCTIONS

The selected functions can be indicated either LED or OSD (On Screen Display) by setting OSDSEL signal.

OSDSEL = "H or "OPEN": LED
 OSDSEL = "L" : OSD

LED state show below table. Please see the recommendation circuit diagram.

Selection function	LED00	LED01	LED02	LED10	LED11	LED12
Default (no-select condition)	L	L	L	H	H	H
Brightness	H	L	L	L	H	H
Contrast	H	L	L	H	L	H
Horizontal display period	H	L	L	H	H	L
CLK delay	L	H	L	L	H	H
Vertical position	L	H	L	H	L	H
Horizontal position	L	H	L	H	H	L
Auto control	L	L	H	L	H	H
All reset	L	L	H	H	L	H
Reserve (no-use)	L	L	H	H	H	L

SELECTION BY OSD

The following pictures appear on the screen by pushing the SEL key. Adjust the each value in best position by pushing UP and DOWN key.

1) Menu



2) Brightness and Sub Brightness

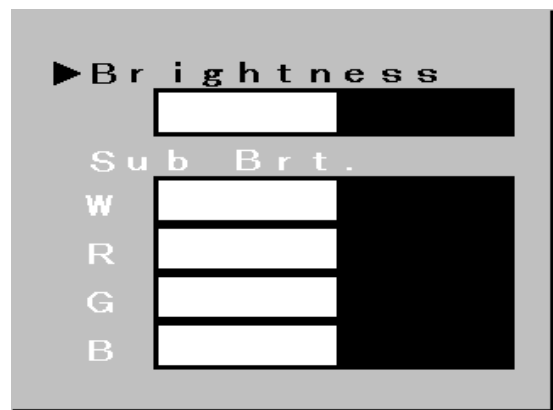

3) Contrast and Sub Contract

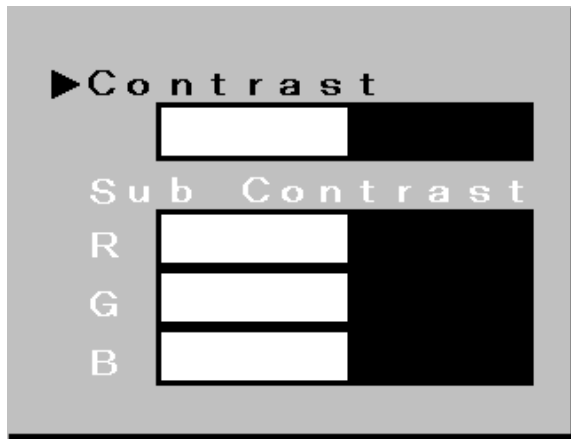

4) Horizontal display period, Clock delay, Vertical display position and Horizontal display position

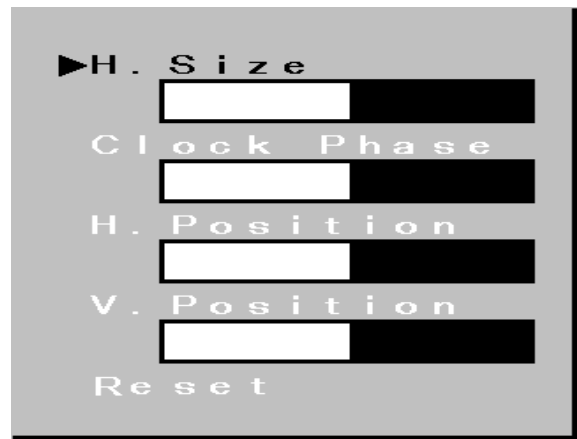

5) Information

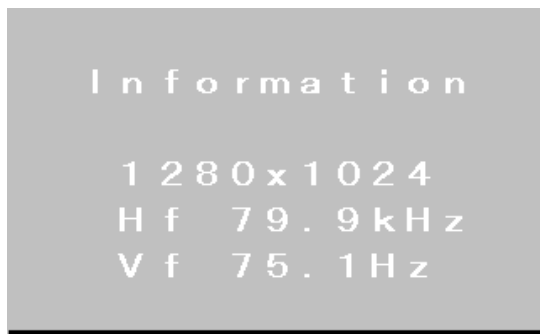

6) All Reset



CONTROL FUNCTION FLOWCHART OF FOR SEL, UP, DOWN AND EXIT

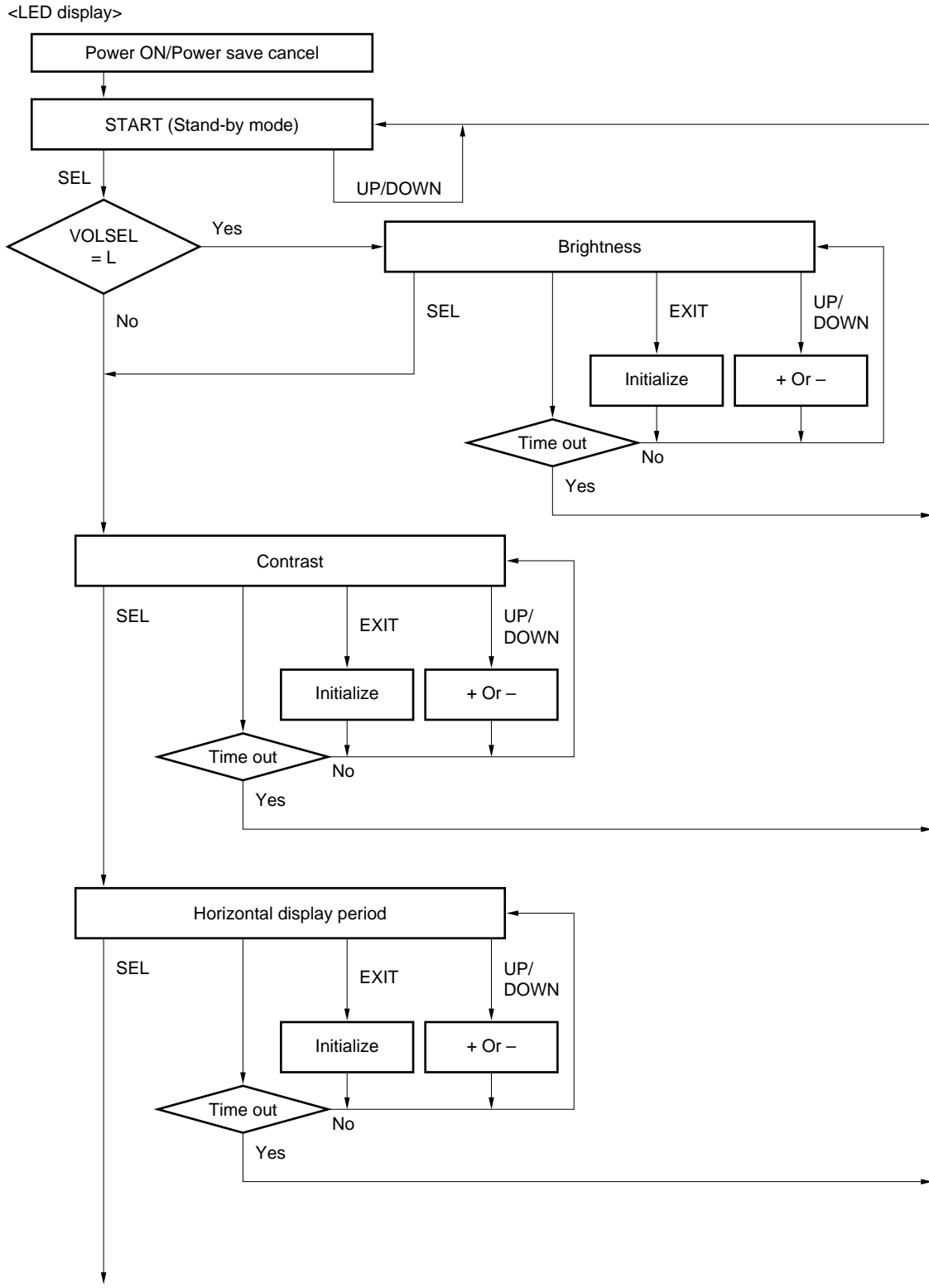

Continued on next page

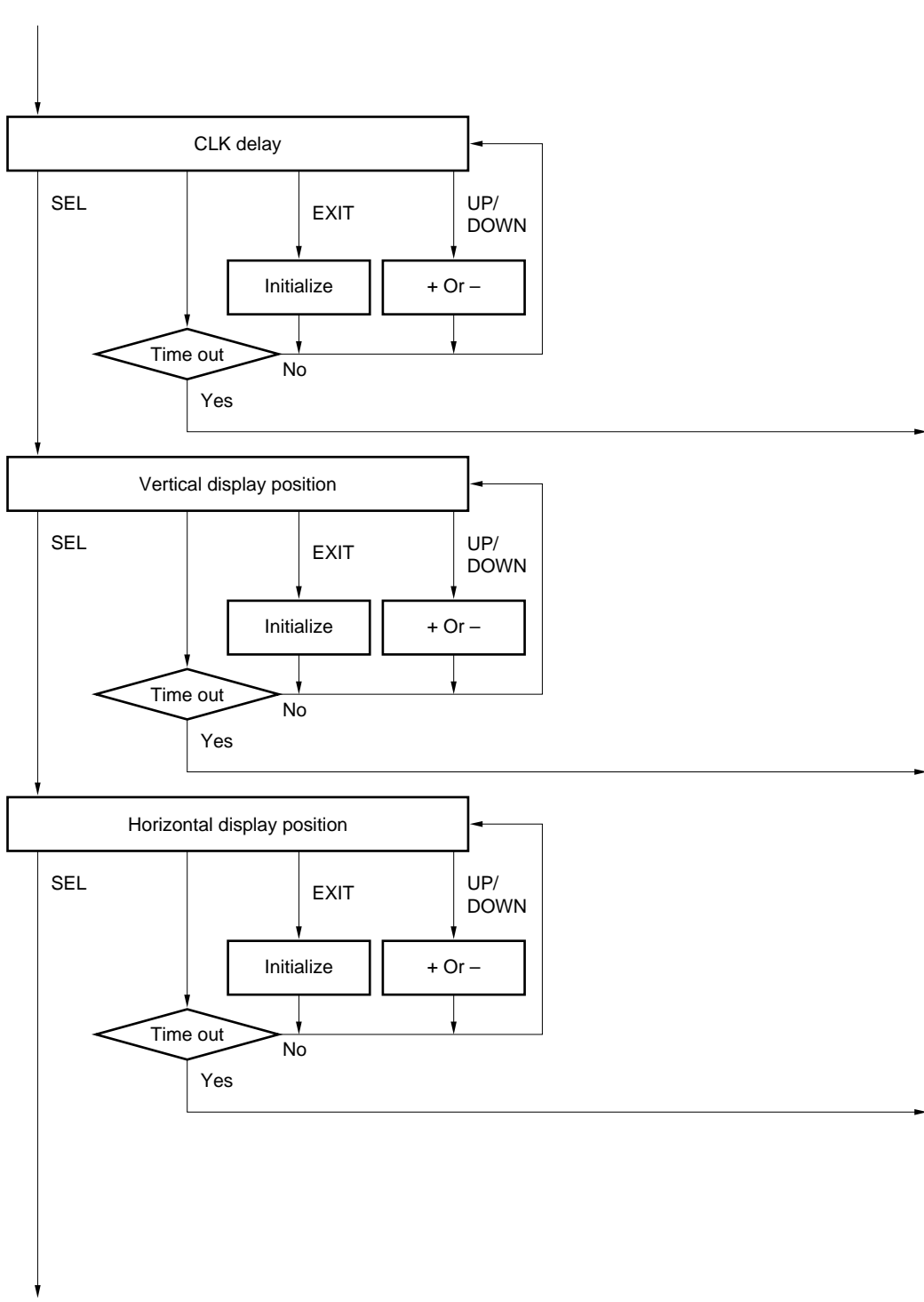

Continued on next page

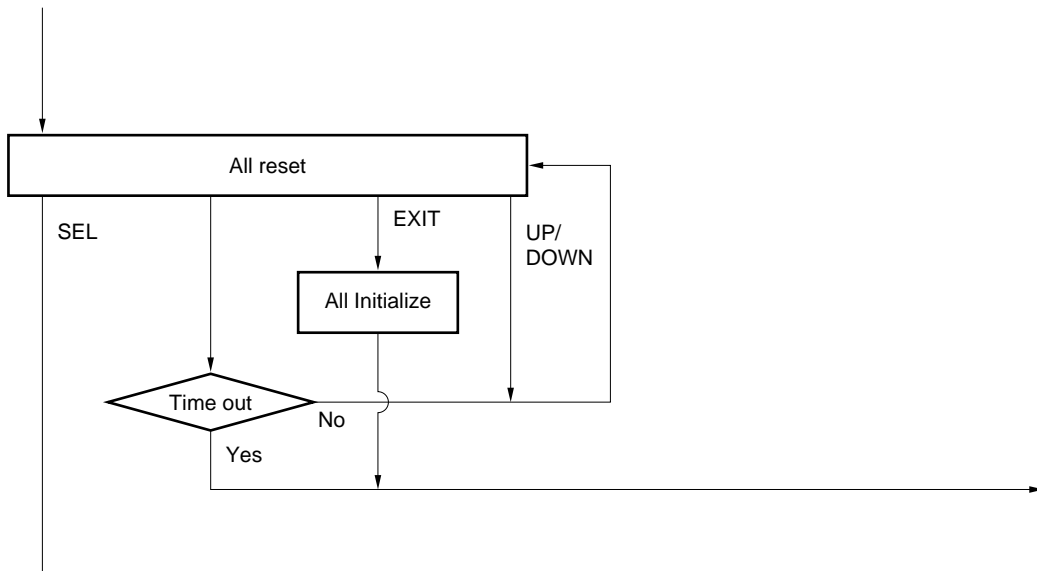

- Note:**
1. The value of the selected signals of the UP and DOWN keys is continuously increased if the input signal is held for more than approximately one second. If it's held less than one second, the value is increased by one.
 2. The EXIT signal initializes the value selected by the SEL key. All Reset function initializes all the values adjusted already.
 3. No key input for more than ten seconds shall be regarded "time out."

OSD display

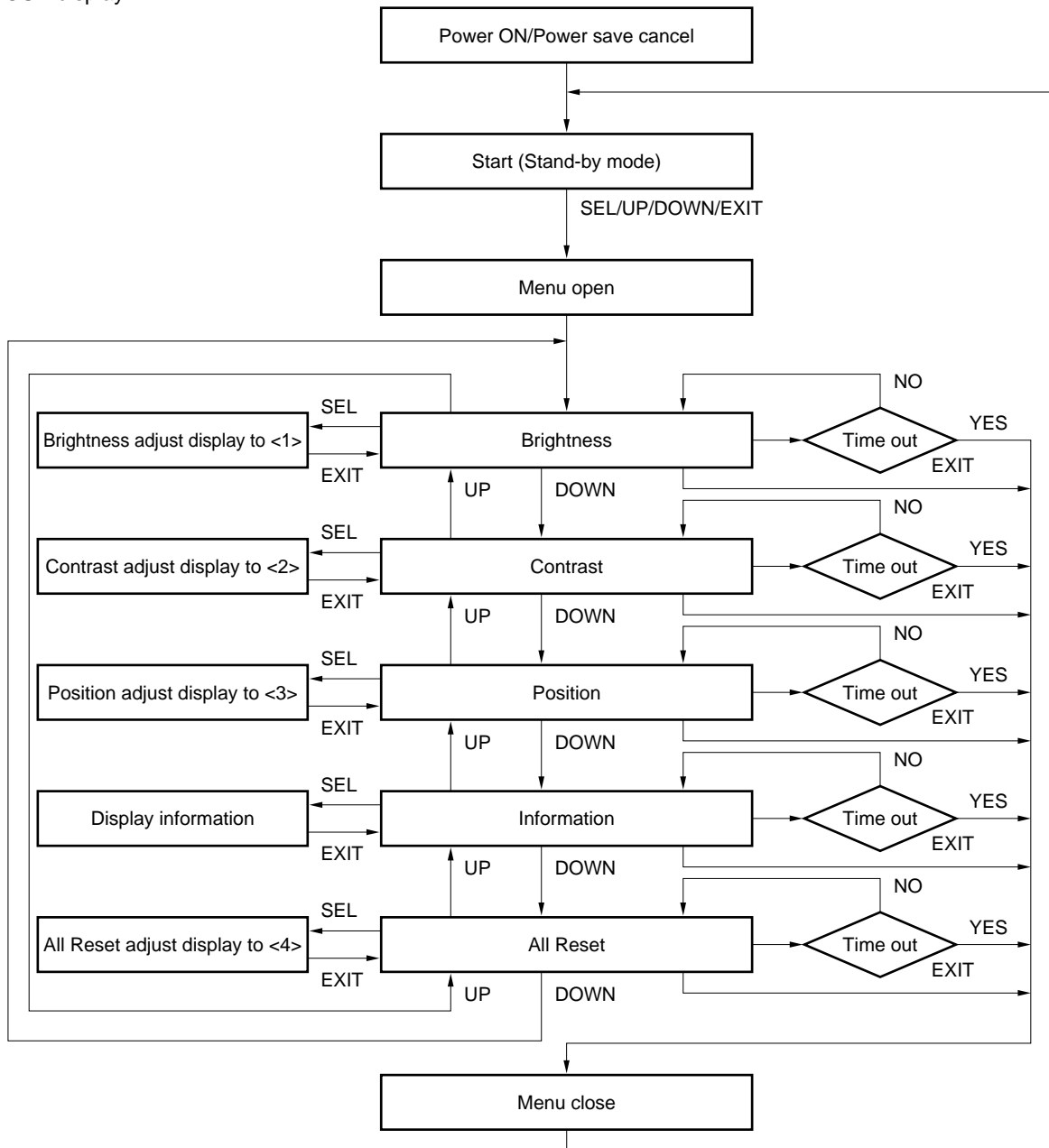

Brightness adjustment

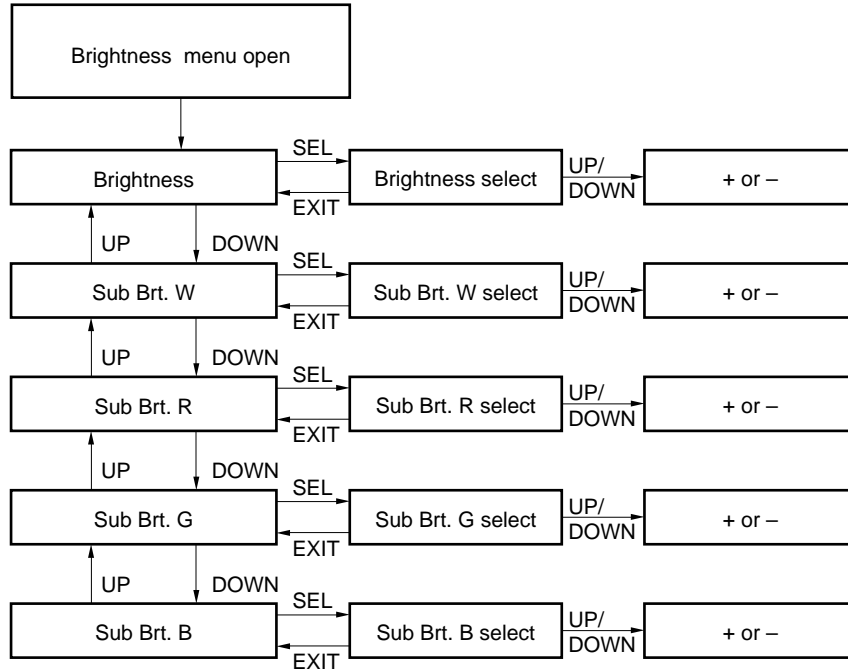

Contrast adjustment

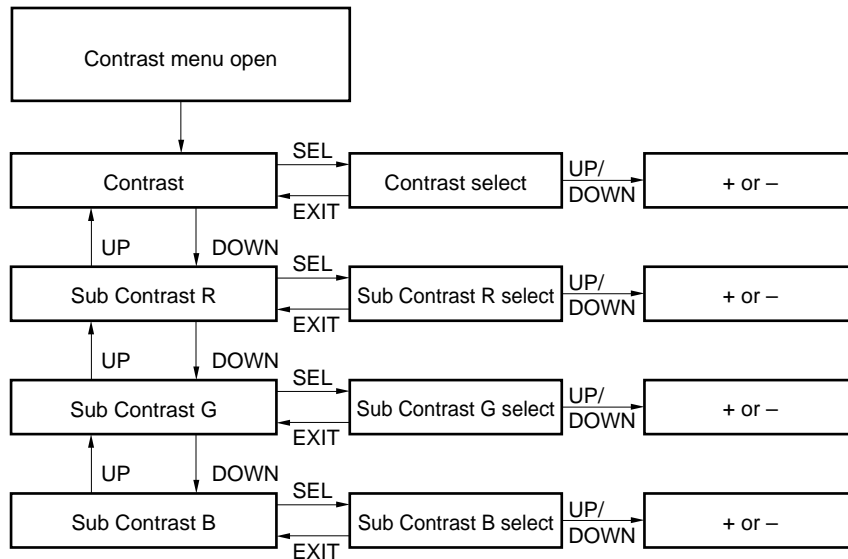

Position adjustment

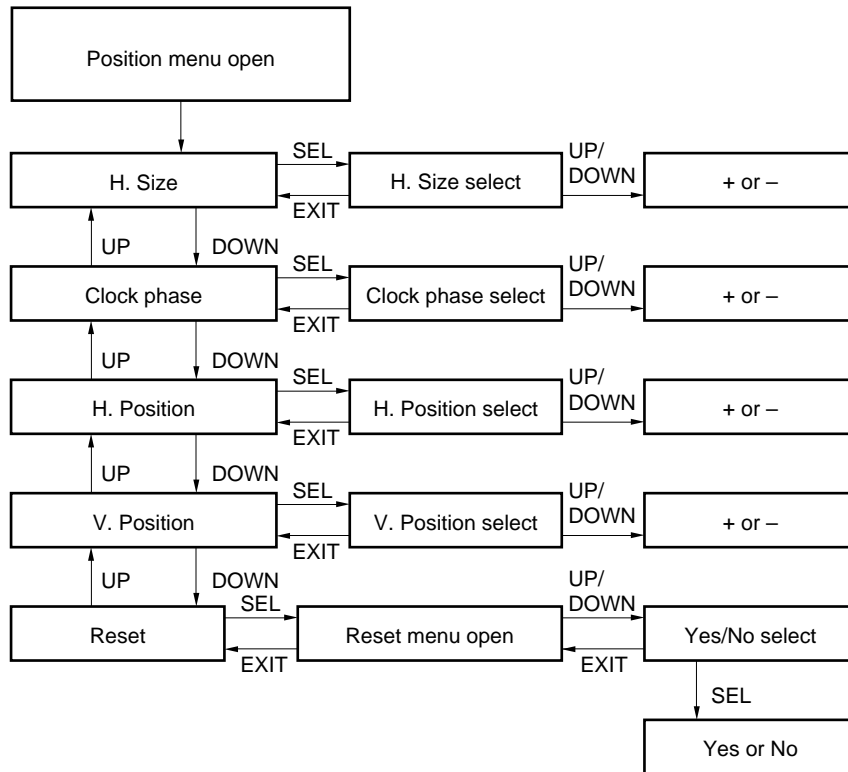

All Reset

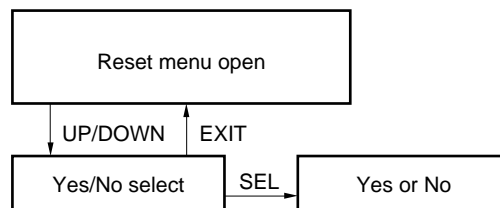

- Notes:**
1. The value of the selected signals by the UP and DOWN key is continuously increased if the input signal is held more than about one second. If it's less than one second, the value is increased by one.
 2. EXIT signal initializes the value selected by the SEL key. The All Reset function initializes all the values adjusted already.
 3. No key input for more than ten seconds shall be regarded "time out."

PRESET TIMINGNS

The twenty kinds of timings below are already programmed in this module. The input synchronous signals are automatically recognized.

No.	Display size	System CLK (MHz)	Hsync (kHz)	Vsync (Hz)	V Pulse (H)	V B. Porch (V)	H Pulse (DOTCLK)	H B. Porch (DOTCLK)	Sync Logic V, H	Remark
1	640 × 400	21.053	24.830	56.432	8	25	96	48	-, -	NEC PC98
2	640 × 480	25.175	31.469	59.992	2	33	96	48	-, -	VGA
3	720 × 400	28.322	31.469	70.087	2	35	108	45	+, -	VGA TXT
4	800 × 600	40.000	37.879	60.317	4	23	128	88	+, +	VESA
5	640 × 480	30.240	35.000	66.667	3	39	64	96	S on G type A	Macintosh
6	640 × 480	31.500	37.500	75.000	3	16	64	120	-, -	VESA
7	720 × 400	35.500	37.927	85.039	3	42	36	144	+, -	VESA Note 1
8	640 × 480	36.000	43.269	85.008	3	25	48	112	-, -	VESA Note 1
9	1024 × 768	65.000	48.363	60.004	6	29	136	160	-, -	VESA
10	800 × 600	49.500	46.875	75.000	3	21	80	160	+, +	VESA
11	832 × 624	57.283	49.735	74.565	3	39	64	224	S on G type A	Macintosh
12	800 × 600	56.250	53.674	85.061	3	27	64	152	+, +	VESA Note 1
13	1024 × 768	75.000	56.476	70.069	6	29	136	144	-, -	VESA
14	1024 × 768	78.750	60.023	75.029	3	28	96	176	-, -	VESA
15	1280 × 1024	108.000	63.981	60.020	3	38	112	248	+, +	VESA
16	1152 × 900	94.500	61.846	60.003	4	31	128	208	CS(-)	SUN
17	1024 × 768	84.375	62.040	77.068	4	31	128	176	CS(-)	SUN
18	1280 × 1024	117.000	71.691	67.189	8	33	112	224	CS(-)	SUN
19	1152 × 900	108.000	71.809	76.149	8	33	128	192	CS(-)	SUN
20	1280 × 1024	135.000	79.976	75.025	3	38	144	248	+, +	VESA

Notes: 1. Out of specification. These modes are less display quality than other guaranteed modes.

2. Even if the preset timing is entered, a little adjustment of the functions such as horizontal period, CLK-delay, and display position, is required. The adjusted values are memorized in every preset number.
3. This module recognizes the synchronous signals with near preset timing of the frequency of HS, Vsync, even if that the signals other than the preset timing that were entered. For instance, it is displayed with presetting number 6 in the case of 640 × 480 dot, HS: 37.861 kHz, Vsync: 72.809 Hz an example).

Adopt the evaluation, because adjustment may not fit in the case that the magnifying ratio differs if you use it with the signals other than the display timing that was preset.

4. Sync on Green signal type

(1) S on G type A

There are no Hsync pulses in Vsync Period.

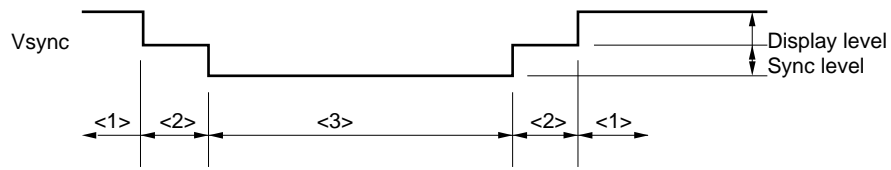

(2) S on G type B

There are Hsync pulses in Vsync Period.

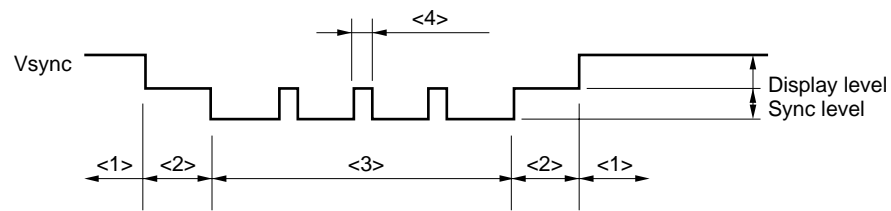

<1> Display level, <2> Black level period, <3> Vsync period, <4> Hsync pulse (equivalent)

DDC FUNCTION

This function corresponds to VESA DDC™ and EDID™ (Structure Version 1).

- Writing mode: WPRT = "L"
- Reading mode: WPRT = "H" or Open

Please write data into the necessary addresses in advance, when you use this function. Data "55H" in address "00H" and "FFH" in other address have already been programmed upon shipping. The input equivalent circuit diagram is as follows.

Internal circuit diagram

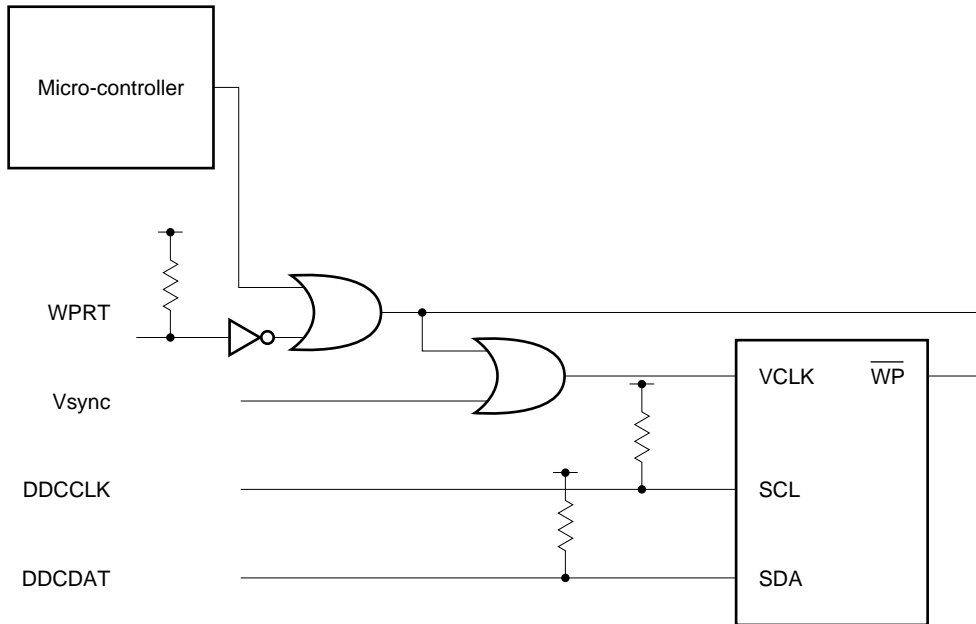

Product: Microchip Technology, Inc.
24LC21
or equivalent

DPMS

This function corresponds to the VESA DPMS™ standard.

VESA DPMS Standard						NL128102AC28-01F	
State	Signal			Power Saving	Recovery Time	Power Saving	Recovery Time
	Horizontal	Vertical	Video				
On	Pulses	Pulses	Active	None	Not applicable	None	Not applicable
Standby	No pulses	Pulses	Blanked	Minimum	Short	Maximum	Short
Suspend	Pulses	No pulses	Blanked	Substantial	Longer	Maximum	Short
Off	No pulses	No pulses	Blanked	Maximum	System dependent	Maximum	Short

INPUT SIGNAL AND DISPLAY POSITION

(1) SXGA Standard Timing

Pixels

D (0, 0)	D (1, 0)	D (2, 0)	D (1279, 0)
D (0, 1)	D (1, 1)	D (2, 1)	D (1279, 1)
D (0, 2)	D (1, 2)	D (2, 2)	D (1279, 2)
.
.
.
.
D (0, 1023)	D (1, 1023)	D (2, 1023)	D (1279, 1023)

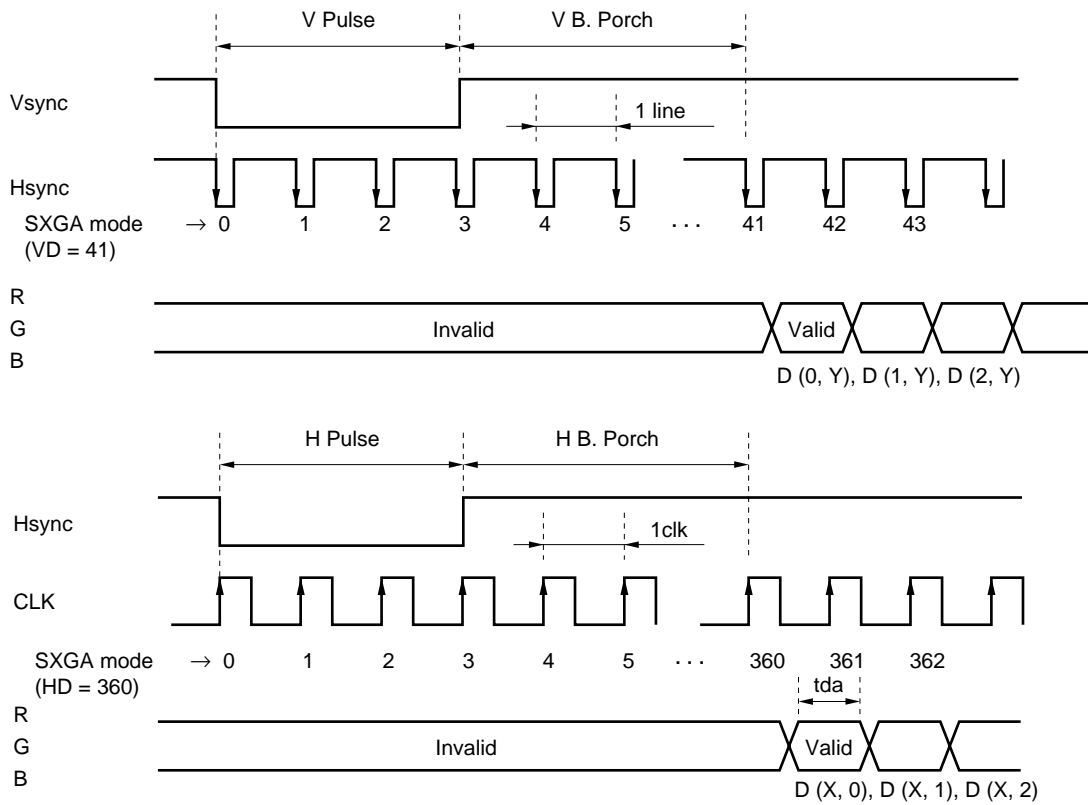

Remark The tda should be more than 4 ns.

EXPANSION FUNCTION (REFERENCE)**(1) How to use expansion mode**

Expansion mode is a function by which to expand screen size in different resolutions. For example, the VGA signal has 640×480 pixels. But if the display data can be expanded to 2.0 times vertically and horizontally, the VGA screen image can be displayed fully on a screen with SXGA resolution. This module automatically recognizes the timing shown in **PRESET TIMINGS** as an expansion mode.

Please adopt this mode after evaluating display quality, because the appearance in the expansion mode may degrade in some cases.

The following table shows the display magnifications for each mode.

Input display	Number of pixels	Magnification	
		Vertical	Horizontal
SXGA	1280×1024	1	1
XGA	1024×768	1.25	1.25
SVGA	800×600	1.6	1.6
VGA	640×480	2.0	2.0
VGA text	720×400	2.5	1.7
PC9801	640×400	2.5	2.0
MAC	832×624	1.6	1.5
SUN	1152×900	1.1	1.1

(3) Display Image

1. XGA mode (1024 × 768)

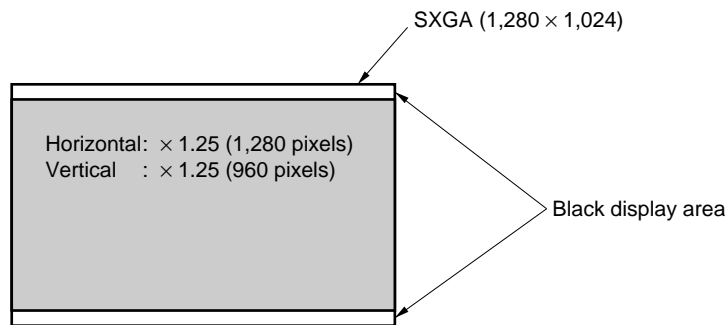

2. SVGA mode (800 × 600)

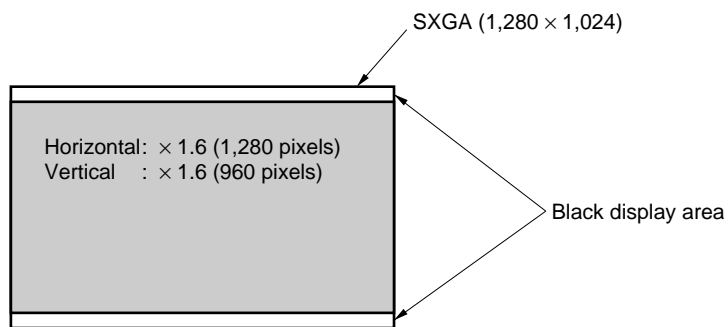

3. VGA mode (640 × 480)

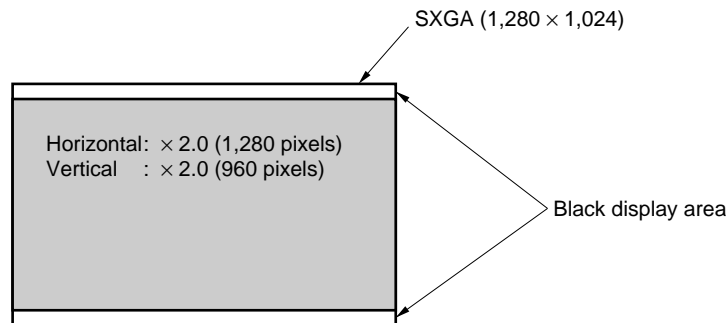

4. PC9801 mode (640 × 400)

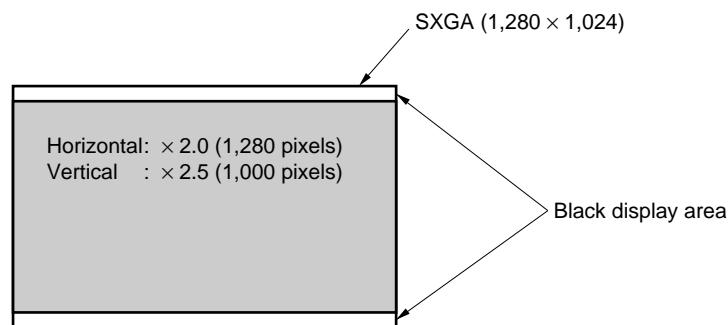

5. VGA text mode (720 × 400)

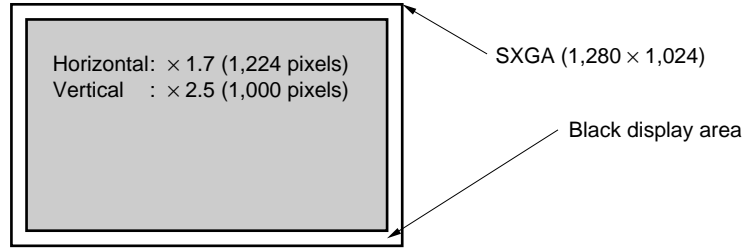

6. 832 × 624 MAC mode (832 × 624)

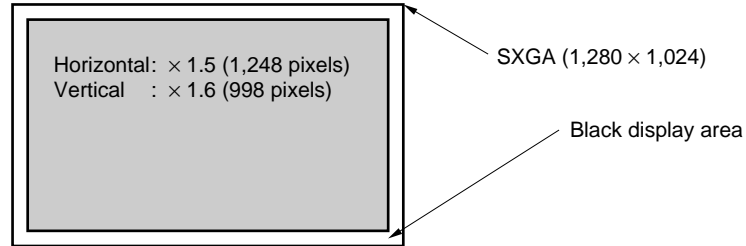

7. SUN mode (1152 × 900)

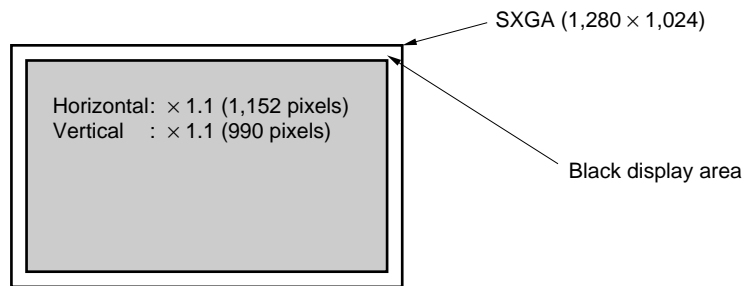

OPTICAL CHARACTERISTICS

(T_a = 25°C, V_{DD} = 12 V, V_{DDB} = 12 V)

Item	Symbol	Condition	Min.	Typ.	Max.	Unit	Remark
Contrast ratio	CR	$\gamma = 2.2$ viewing angle $\theta_{x\pm} = 0^\circ, \theta_{y-} = 0^\circ$ White/Black, at center	200	300	–	–	Note 1
Luminance	Lumax	White, at center	150	200	–	cd/m ²	Note 2
Luminance uniformity	–	White	–	1.1	1.30	–	Note 3

Reference data

(T_a = 25°C, V_{DD} = 12 V, V_{DDB} = 12 V)

Item	Symbol	Condition	Min.	Typ.	Max.	Unit	Remark
Color gamut	C	$\theta_{x\pm} = 0^\circ, \theta_{y\pm} = 0^\circ$, at center, to NTSC	50	60	–	%	–
Viewing angle range	θ_{x+}	CR > 10, $\theta_{y+} = 0^\circ, \theta_{y-} = 0^\circ$	70	85	–	deg.	Note 4
	θ_{x-}		70	85	–	deg.	
	θ_{y+}	CR > 10, $\theta_{x+} = 0^\circ, \theta_{x-} = 0^\circ$	70	85	–	deg.	
	θ_{y-}		70	85	–	deg.	
Response time	T _{on}	Black (0%) to white (90%)	–	40	70	ms	Note 5
	T _{off}	White (100%) to Black (10%)	–	35	60	ms	
Luminance control range	–	Maximum luminance: 100%	–	30 to 100	–	%	–

Notes: 1. The contrast ratio is calculated by using the following formula.

$$\text{Contrast ratio (CR)} = \frac{\text{Luminance with all pixels in white}}{\text{Luminance with all pixels in black}}$$

2. The luminance is measured after the module has been working for 20 minutes with all pixels in white. Typical value is measured after luminance saturation, more than one hour after burn-in. The timing is SXGA 60 Hz mode, preset timing No. 15. See detail Page 23 PRESET TIMINGS.

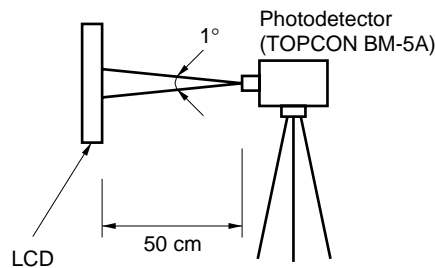

3. Luminance uniformity is calculated by using the following formula.

$$\text{Luminance uniformity} = \frac{\text{Maximum luminance}}{\text{Minimum luminance}}$$

The luminance is measured at or near the five points shown below.

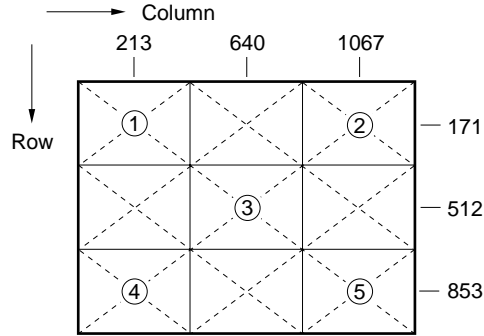

4. Definitions of viewing angles are as follows.

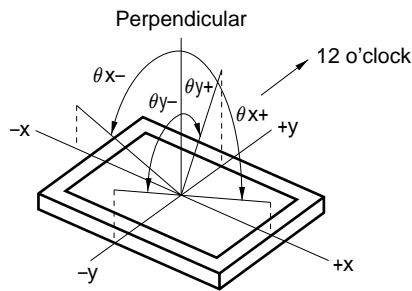

5. Definition of response time is as follows.

The photo-detector output signal is measured when the luminance changes from black to white or from white to black.

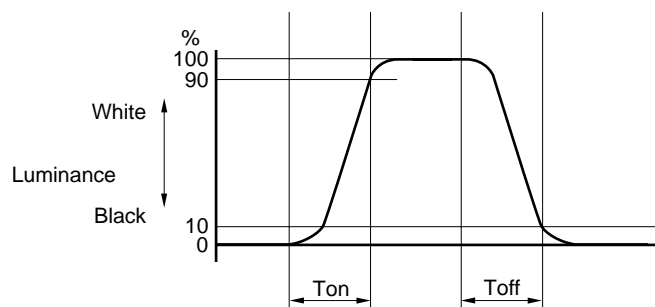

RELIABILITY TEST

Test item		Test condition
High temperature/humidity operation	Note 1	60 ± 2°C, RH = 60% 240 hours Display data is black.
Heat cycle (operation)	Note 1	<1> 0°C ± 3°C 1 hour 55°C ± 3°C 1 hour <2> 50 cycles, 4 hours/cycle <3> Display data is black.
Thermal shock (nonoperation)	Note 1	<1> -20°C ± 3°C 30 minutes 60°C ± 3°C 30 minutes <2> 100 cycles <3> Temperature transition time within 5 minutes
Vibration (nonoperation)	Notes 1, 2	<1> 5 - 100 Hz, 11.76 m/s ² (1.2 G) 1 minute/cycle X, Y, Z direction <2> 10 times each direction
Mechanical shock (nonoperation)	Notes 1, 2	<1> 294 m/s ² (30 G), 11 ms X, Y, Z direction <2> 3 times each direction
ESD (operation)	Notes 1, 3	150 pF, 150 Ω, ±10 kV 9 places on a panel 10 times each place at one-second intervals
Dust (operation)	Note 1	15 kinds of dust (JIS Z 8901) Hourly 15 seconds stir, 8 times repeat

- Notes:**
1. Display function is checked by the same condition as the LCD module outgoing inspection.
 2. Physical damage.
 3. Discharge points “●” are shown in the figure.

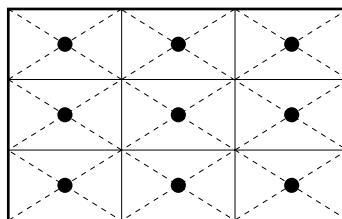

GENERAL CAUTIONS

Because the following figures and statements are very important. Please be sure you understand their contents completely.

	CAUTION This figure is a mark that you will get hurt and/or the module will have damages when you make a mistake to operate.
---	---

	This figure is a mark that you will get an electric shock when you make a mistake to operate.
---	---

	This figure is a mark that you will get hurt when you make a mistake to operate.
---	--

 CAUTIONS

	Do not touch an inverter, on which there is a caution label, while the LCD module is in operation, because of high voltage.
---	---

(1) Caution when taking out the module

- a) Pick up the pouch only, when removing out the module from the carrier box.

(2) Cautions for handling the module

- a) As the electrostatic discharges may break the LCD module, handle the LCD module with care against electrostatic discharges.
- b)  As LCD panel and backlight element are made from fragile glass material, impulse and pressure to the LCD module should be avoided.
- c) As the surface of polarizer is very soft and easily scratched, use a soft dry cloth without chemicals for cleaning.
- d) Do not pull the interface connectors in or out while the LCD module is operating.
- e) Put the module display side down on that horizontal plane.
- f) Handle connectors and cables with care.
- g) When the module is operating, do not lose CLK, HS or Vsync signal. If any one or more of these signals is lost, the LCD panel would be damaged.
- h) The torque to mounting screw should never exceed 0.451 N·m (4.6 kgf·cm).
- i) Don't push or rub the surface of LCD module please. If you do the scratches or the rubbing marks may be left on the surface of the module.

(3) Cautions regarding atmosphere

- a) Dew drop atmosphere should be avoided.
- b) Do not store and/or operate the LCD module in high-temperature and/or high-humidity atmosphere. Storage in an anti-static pouch and in a room temperature atmosphere is recommended.
- c) This module uses cold cathode fluorescent lamps. The lifetime of lamps is shortened if the module is operated at low temperatures.
- d) Do not operate the LCD module in a high magnetic field.

(4) Cautions about the module characteristics

- a) Do not apply a fixed pattern for a long time to the LCD module at product aging. It may cause image sticking. Use the screen savers if the display pattern is fixed for a long time.
- b) This module has the retardation film which may cause the variation of the color hue in the different viewing angles. The ununiformity may appear on the screen in the high-temperature operation.

- c) The light vertical stripe may be observed depending on the display pattern. This is not defects nor malfunctions.
- d) The noise from the inverter circuit may be observed in the luminance control mode. This is not defects nor malfunctions.

(5) Other cautions

- a) Do not disassemble and/or reassemble the LCD module.
- b) Do not readjust variable resistors or switches, etc.
- c) When returning the module for repair, etc, pack the module so it will not be broken. We recommend using the original shipping packages.
- d) In case that the scan converter is used to convert VGA signal to NTSC, it is recommended using the frame-memory type, not the line-memory.

The liquid crystal display has the following specific characteristics. These are not defects nor malfunctions.

- The ambient temperature may affect the optical characteristics of this module.
- This module has cold cathode tube for backlight. Optical characteristics, like luminance or uniformity, will change over time.

Uneven brightness and/or small spots may be noticed, depending on different display patterns.

[MEMO]

[MEMO]

[MEMO]

No part of this document may be copied or reproduced in any form or by any means without the prior written consent of NEC Corporation. NEC Corporation assumes no responsibility for any errors which may appear in this document.

NEC Corporation does not assume any liability for infringement of patents, copyrights or other intellectual property rights of third parties by or arising from use of a device described herein or any other liability arising from use of such device. No license, either express, implied or otherwise, is granted under any patents, copyrights or other intellectual property rights of NEC Corporation or others.

While NEC Corporation has been making continuous effort to enhance the reliability of its electronic components, the possibility of defects cannot be eliminated entirely. To minimize risks of damage or injury to persons or property arising from a defect in an NEC electronic component, customers must incorporate sufficient safety measures in its design, such as redundancy, fire-containment, and anti-failure features. NEC devices are classified into the following three quality grades:

"Standard," "Special," and "Specific". The Specific quality grade applies only to devices developed based on a customer designated "quality assurance program" for a specific application. The recommended applications of a device depend on its quality grade, as indicated below. Customers must check the quality grade of each device before using it in a particular application.

Standard: Computers, office equipment, communications equipment, test and measurement equipment, audio and visual equipment, home electronic appliances, machine tools, personal electronic equipment and industrial robots

Special: Transportation equipment (automobiles, trains, ships, etc.), traffic control systems, anti-disaster systems, anti-crime systems, safety equipment and medical equipment (not specifically designed for life support)

Specific: Aircrafts, aerospace equipment, submersible repeaters, nuclear reactor control systems, life support systems or medical equipment for life support, etc.

The quality grade of NEC devices is "Standard" unless otherwise specified in NEC's Data Sheets or Data Books. If customers intend to use NEC devices for applications other than those specified for Standard quality grade, they should contact an NEC sales representative in advance.

(Note)

- (1) "NEC" as used in this statement means NEC Corporation and also includes its majority-owned subsidiaries.
- (2) "NEC electronic component products" means any electronic component product developed or manufactured by or for NEC (as defined above).