



LCD Module Technical Specification

First Edition
Jan 1, 2001
Final Revision

T-51431L016J-FW-P-AA

Checked by (Quality Assurance Div.)

Checked by (Design Engineering Div.)

Prepared by (Production Div.)

Table of Contents

1. Applications.....	2
2. Features.....	2
3. Mechanical Specifications.....	2
4. Mechanical Drawing of panel.....	3
5. Input / Output Terminals.....	4
6. Pixel arrangement and input connector pin No.....	6
7. Absolute Maximum Ratings.....	7
8. Electrical Characteristics.....	7
9. Power Sequence.....	18
10. Optical Characteristics.....	18
11. Handling Cautions.....	21
12. Reliability.....	22
13. Indication of Lot Number Label.....	22
14. Block Diagram.....	23

Revision History

Rev.	Date	Page	Comment

1. Application

This technical specification applies to 1.6" color TFT-LCD panel. The 1.6" color TFT LCD panel is designed for camcorder, digital camera application and other electronic products which require high quality flat panel displays.

2. Features

- . Compatible with NTSC or PAL system
- . High Resolution : 56,160 Dots
- . Optimum Viewing Direction: 6 o'clock
- . Up/Down and Left/Right Image Reversion

3. Mechanical Specifications

Parameter	Specifications	Unit
Screen Size	1.6 (diagonal)	inch
Surface Treatment	Anti-Glare	
Display Format	240×234	dot
Active Area	32.4 (H)×24.336 (V)	mm
Dot Pitch	0.135 (H)×0.104 (V)	mm
Pixel Configuration	Delta	
Outline Dimension	45.9 (W)×38.6 (H)×5.9 (D)	mm
Weight	18±3	g

5. Input / Output Terminals

Pin No	Symbol	I/O	Description	Remark
1	STH1	I/O	Start pulse for source driver	Note 5-1
2	AV _{SS}	I	Analog GND for source driver	
3	AV _{DD}	I	Analog power input for source driver	Note 5-2
4	V _B	I	Video Input B	Note 5-4
5	V _G	I	Video Input G	
6	V _R	I	Video Input R	
7	V _{SS}	I	Digital GND	
8	V _{DD}	I	Digital power input	Note 5-3
9	CPH1	I	Sampling and shift clock for source driver	
10	CPH2	I	Sampling and shift clock for source driver	
11	CPH3	I	Sampling and shift clock for source driver	
12	STH2	I/O	Start pulse for source driver	Note 5-1
13	Q2H	I	Video input rotation control	
14	INH	I	Output enable for source driver	
15	R/L	I	Left/Right Control for source driver	Note 5-1
16	V _{COM}	I	Common electrode voltage	Note 5-4
17	V _{COM}	I	Common electrode voltage	
18	XOE	I	Output enable for gate driver	
19	CPV	I	Clock input for gate driver	
20	U/D	I	Up/Down Control for gate driver	
21	DIO2	I/O	Vertical start pulse	Note 5-5
22	DIO1	I/O	Vertical start pulse	
23	V _{GL}	I	Gate off voltage(alternative every 1-H)	Note 5-4
24	V _{EE}	I	Gate driver negative voltage	Note 5-6
25	V _{SS}	I	GND	
26	V _{CC}	I	Logic power for gate driver	Note 5-3
27	V _{GH}	I	Gate on voltage	Note 5-7
28	NC	-	No connection	-

Note 5-1 : STH1, STH2 and R/L mode

R/L	STH1	STH2	Remark
High(VDD)	Input	Output	Left to right
Low(0 Volt.)	Output	Input	Right to left

Note 5-2 : AV_{DD} = +5V (Typ.)

Note 5-3 : V_{DD}, V_{CC} = +5V or +3.3V (Typ.)

Note 5-4 : V_{COM} = 6V_{PP}.

i) Phase of the video signal input and V_{COM}

The relation between these values could refer to 8-1 Operating condition.

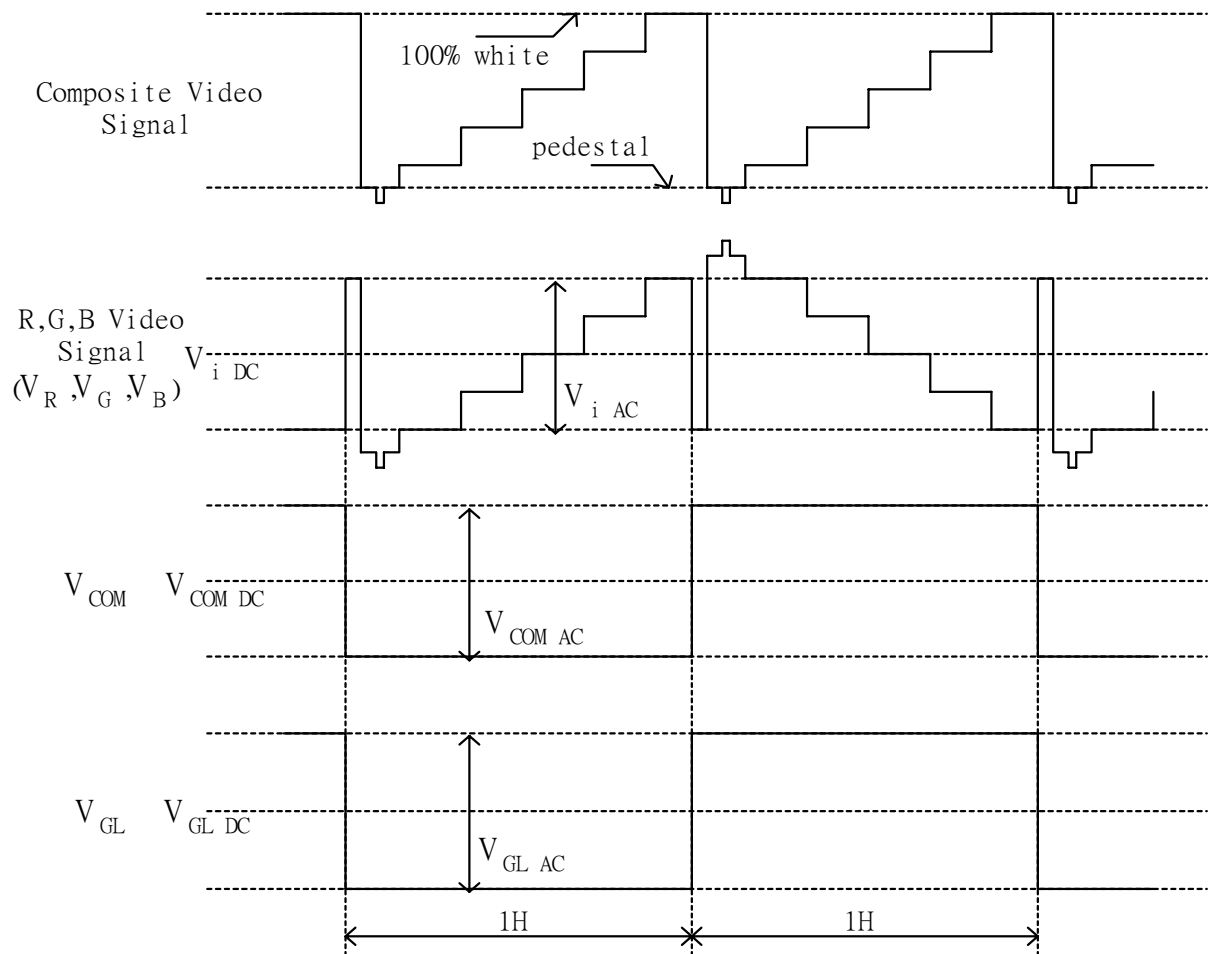

Fig.1

ii) Liquid crystal transmission of the video signal input, V_{COM} and timing

	V_{COM}	
	H Level	L Level
Video Signal Input Maximum	Black	White
Video Signal Input Minimum	White	Black

White : maximum transmission / Black : minimum transmission

Note 5-5 : DIO1, DIO2 and U/D mode

U/D	DIO1	DIO2	Remarks
Hi (VDA)	Input	Output	Down to up
Low (0 V.)	Output	Input	Up to down

Note 5-6 : $V_{EE} = -15V$ (Typ.).

Note 5-7 : $V_{GH} = 15V$ (Typ.).

6. Pixel arrangement and input connector pin NO.

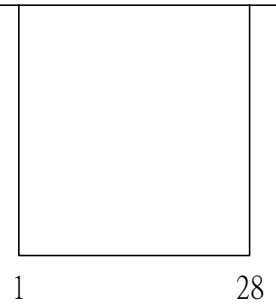
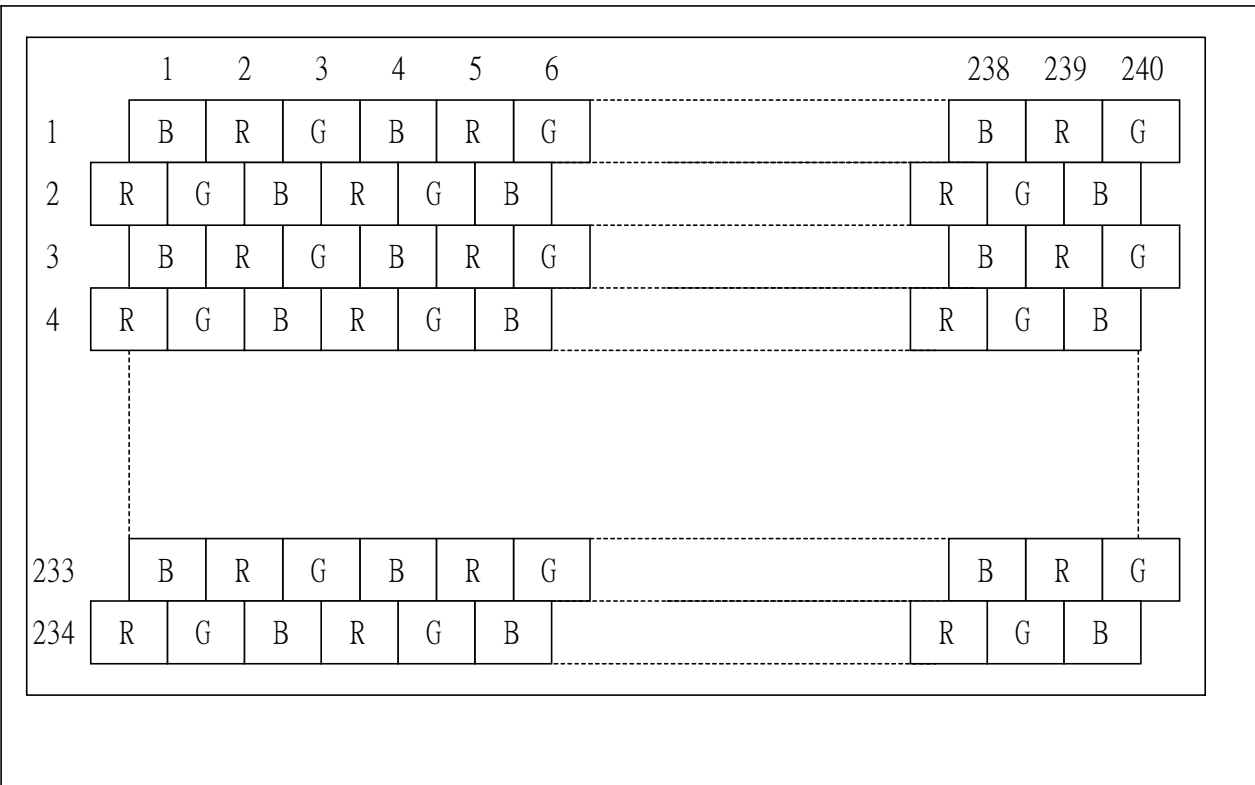

7. Absolute Maximum Ratings:

The followings are maximum values , which if exceeded, may cause faulty operation or damage to the unit.

GND = 0 V, Ta = 25

Parameter		Symbol	MIN.	MAX.	Unit	Remark
Supply Voltage for Source Driver	Analog	AV _{DD}	-0.3	+7	V	
	Digital	V _{DD}	-0.3	+7		
Supply Voltage for Gate Driver	Positive	V _{GH}	-0.3	+45	V	
	Negative	V _{GL}	-23	+0.3	V	
		V _{GH} V _{GL}	+15	+40	V	
Analog input voltage	V _{Video}		-0.3	+7.3	V	Notes:7-1
Storage Temperature			-20	+70	°C	
Operation Temperature			0	+60	°C	Notes:7-2

Notes 7-1 : Analog Input Voltage means V_R, V_G, V_B.

Notes 7-2 : Operating Temperature define that contrast, response time, other display optical character are Ta=+25.

8. Electrical Characteristics

8-1) Operating conditions

Item	Symbol	Min.	Typ.	Max.	Unit	Remark
Power supply	V _{CC} V _{DD}	+3.0	+3.3	+3.6	V	3.3V operating
		+4.5	+5.0	+5.5	V	5.0V operating
	AV _{DD}	+4.5	+5.0	+5.5	V	
	V _{GH}	+14.5	+15.0	+15.5	V	
	V _{EE}	-14.5	-15.0	-15.5	V	
	V _{GLAC}	-	+6	-	V _{P-P}	AC component of V _{GL}
	V _{GLDC}	-11.5	-12.0	-12.5	V	DC component of V _{GL}
Video signal (V _R , V _G , V _B)	V _{iAC}	-	+4.0	+4.6	V	AC component
	V _{iDC}	-	+2.5	-	V	DC component
V _{com}	V _{CAC}	-	+6.0	-	V _{P-P}	AC component of V _{com}
	V _{CDC}	+0.9	+1.0	+1.1	V	AC component
	H level	V _{IH}	0.7V _{DD}	-	V	Note 8-1
	L level	V _{IL}	-	-	0.3V _{DD}	

Note 8-1 : STH1,STH2,CPH1,CPH2,CPH3,Q2H,INH,CPV,XOE,DIO1,DIO2.

8-2) Current consumption (GND=AV_{SS}=0V)

Ta= 25

Parameter	Symbol	Condition	Min.	Typ.	Max.	Unit	Remark
Current for driver	I _{GH}	V _{GH} =15V	-	0.015	0.02	mA	
	I _{GL}	V _{GL} =-12V	-	0.09	0.15	mA	V _{GL} center voltage
	I _{CC}	V _{CC} , V _{AA} =5V	-	0.09	0.15	mA	
	I _{ADD}	V _{ADD} =5V	-	0.73	0.9	mA	
	I _{EE}	V _{EE} =-15V	-	0.09	0.15	mA	
I _{DD}	V _{DD} =5V	-	0.2	0.25	mA		

8-3) Backlight driving & Power Consumption

Pin No	Symbol	Description	Remark
1	VL1	Input terminal (Hi voltage side)	
2	VL2	Input terminal (Low voltage side)	Note 8-2

Note 8-2 : Low voltage side of backlight inverter connects with Ground of inverter circuits.

Ta= 25

Parameter	Symbol	Min.	Typ.	Max.	Unit	Remark
Lamp voltage	V _L	145	170	195	Vrms	I _L =3mA
Lamp current	I _L		3		mA	
Lamp frequency	P _L	-	35	95	KHz	Note 8-3
Kick-off voltage(25°C)	Vs	-	-	500	Vrms	
Kick-off voltage(0°C)	Vs	-	-	750	Vrms	

Note 8-3 : The wave form of lamp driving voltage should be as closed to a perfect SIN wave as possible.

Power Consumption

Ta= 25

Parameter	Symbol	Conditions	TYP.	MAX	Unit	Remark
LCD Panel Power Consumption			8	8.5	mW	Note 8-4
Backlight Lamp Power Consumption			0.51	0.55	W	Note 8-5
Total Power Consumption			0.518	0.56	W	

Note 8-4 : The power consumption for backlight is not included.

Note 8-5 : Backlight lamp power consumption is calculated by I_L × V_L.

8-4) Input / Output Connector

A) LCD Module Connector
 FFC Down Connector
 28 Pins
 Pitch : 0.5 mm

B) Backlight Connector
 JST BHR-03VS-1
 Pin No. : 3
 Pitch : 4 mm

8-5) Timing Characteristics Of Input Signals

Characteristics	Symbol	Min.	Typ.	Max.	Unit	Remark
1Field Scanning Period	t1V	-	262.5	-	H	
1Line Scanning Period	t1H	-	63.5	-	μs	
Source Driver Operating Frequency	fhc	0.5	1.57	2.5	MHz	
Signal Sampling Pulse Width	tchw	400	637	2000	ns	
Signal Sampling Pulse Delay	tchd	190.6	212.3	233	ns	tchd 12,23
Signal Sampling Pulse Width(H)	tchwh	-	316.5	-	ns	
Signal Sampling Pulse Delay(L)	tchwl	-	316.5	-	ns	
Source Start Signal Pulse Width	tshw	-	637	-	ns	
Source Start Signal Setup Time	tshset	10	-	-	ns	
Source Start Signal Hold Time	tshhld	20	-	-	ns	
Source Output Enable Pulse Width	tohw	2	4	-	μs	
Source Start Signal Rising Time	tss	-	9.8	-	μs	
Video Input Signal Start Point	tvs	-	10.0	-	μs	
Phase Difference Between OEH&CPV	toc	1.5	2.3	-	μs	
Gate Clock Period	tcvw	10	63.5	-	μs	
Gate Clock Pulse Width(H)	tcvwh	10	31.7	48	μs	
Gate Clock Pulse Width(L)	tcvwl	10	31.7	48	μs	
Gate Start Signal Pulse Width	tsvw	5	63.5	126**	μs	
Gate Start Signal Setup Time	tsvset	5	53.2	-	μs	
Gate Start Signal Hold Time	tsvhld	5	10.3	-	μs	
Phase Difference Between OEH&STH	tosp	-	4	-	μs	
Phase Difference Between SYNC&OEH	tohs	-	1.4	-	μs	
Gate Output Enable Pulse Width	toev	-	2.5	-	μs	
Vcom Delay Time	tdcom	-	-	3	μs	
RGB Delay Time	tdRGB	-	-	2	μs	
Vertical Display Start	tsv	-	3	-	tH	

8-6)Signal Timing Waveforms

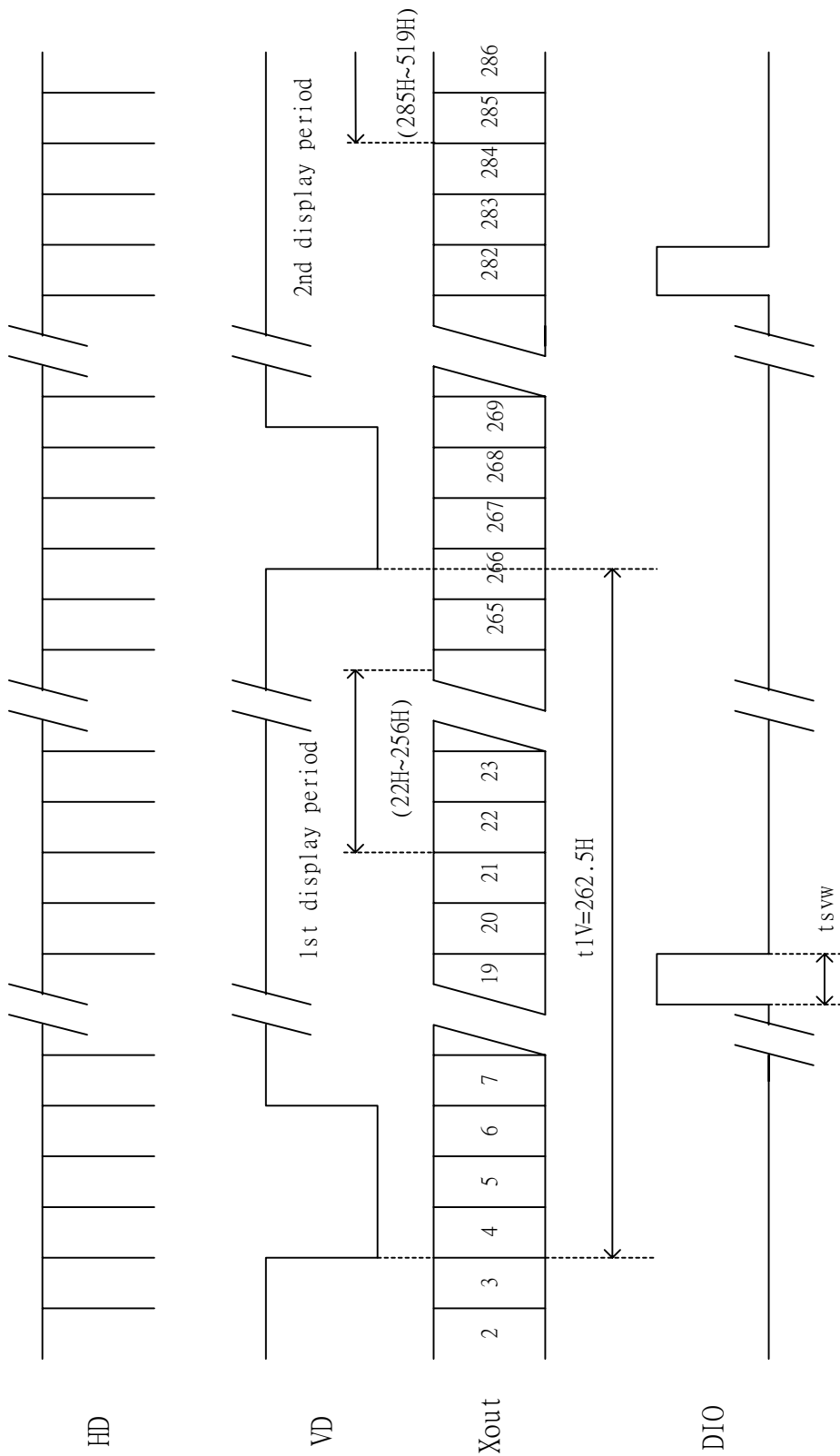
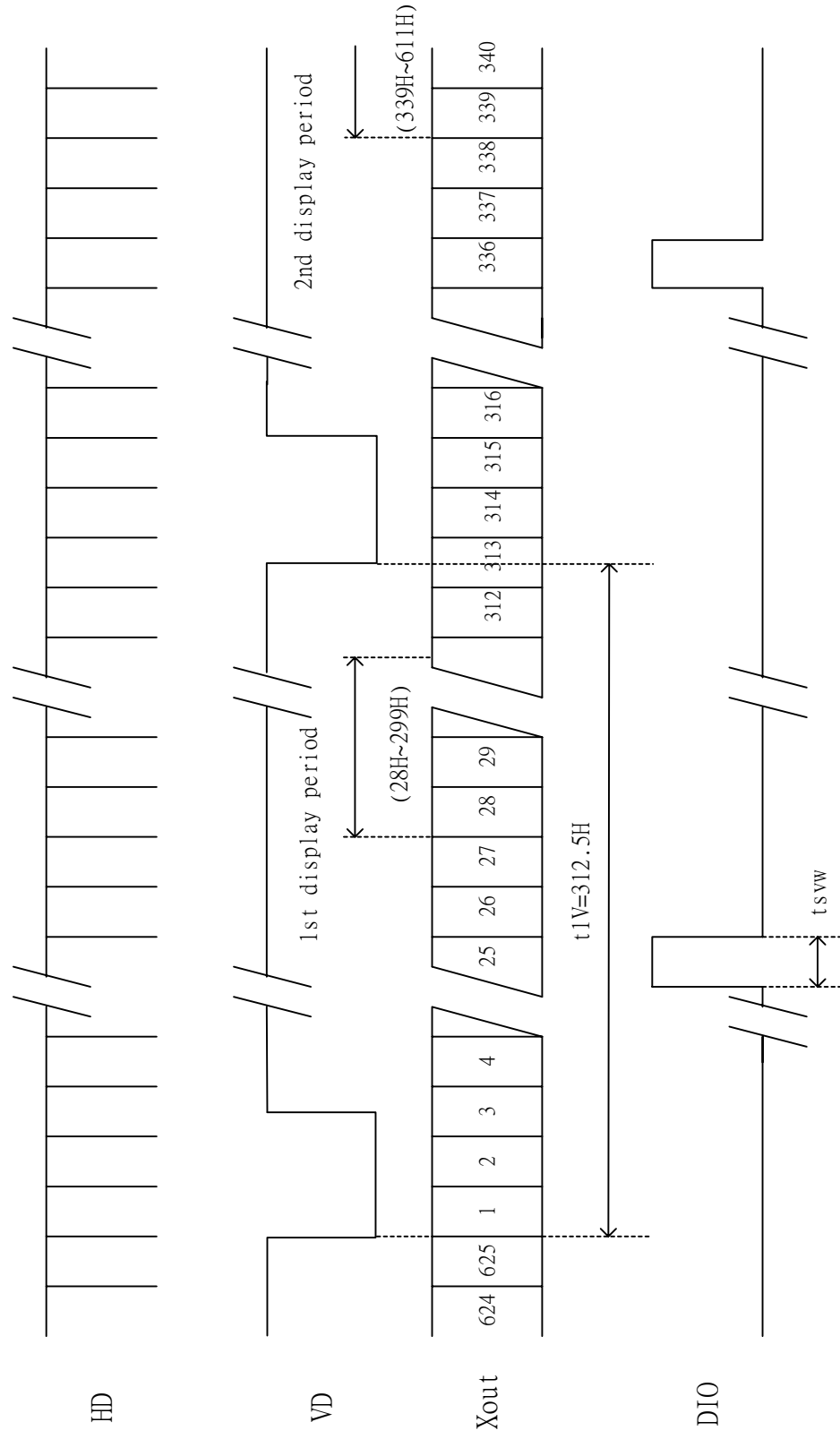

Fig. 8-1 Vertical Start Line for NTSC



** odd field : Scan lines 14n+6 14n+12 (n = 2, 3, 4..) are not displayed.
 even field : Scan lines 14n+12 14n+20 (n = 2, 3, 4..) are not displayed.

Fig. 8-1 Vertical Start Line for PAL

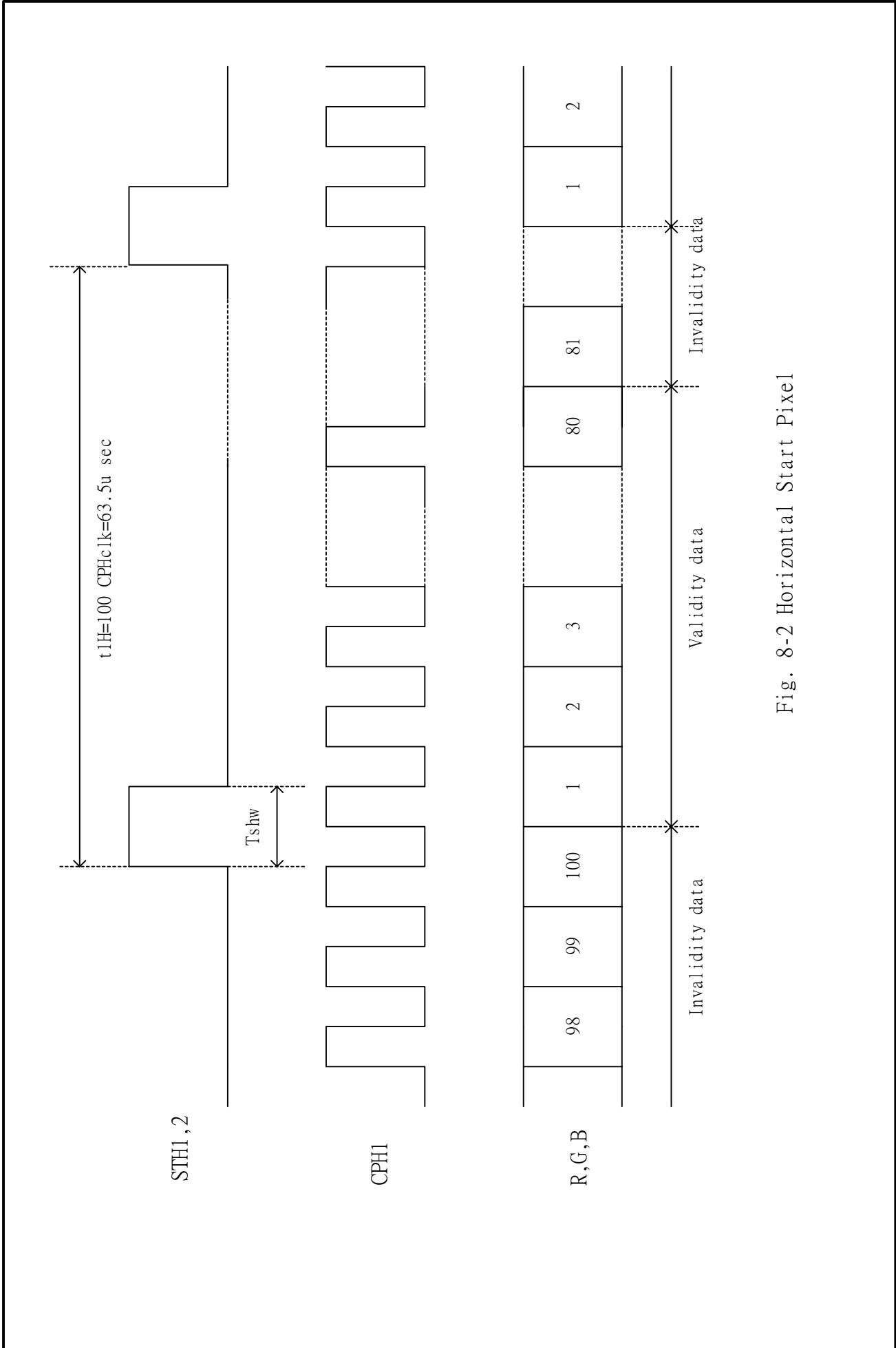

Fig. 8-2 Horizontal Start Pixel

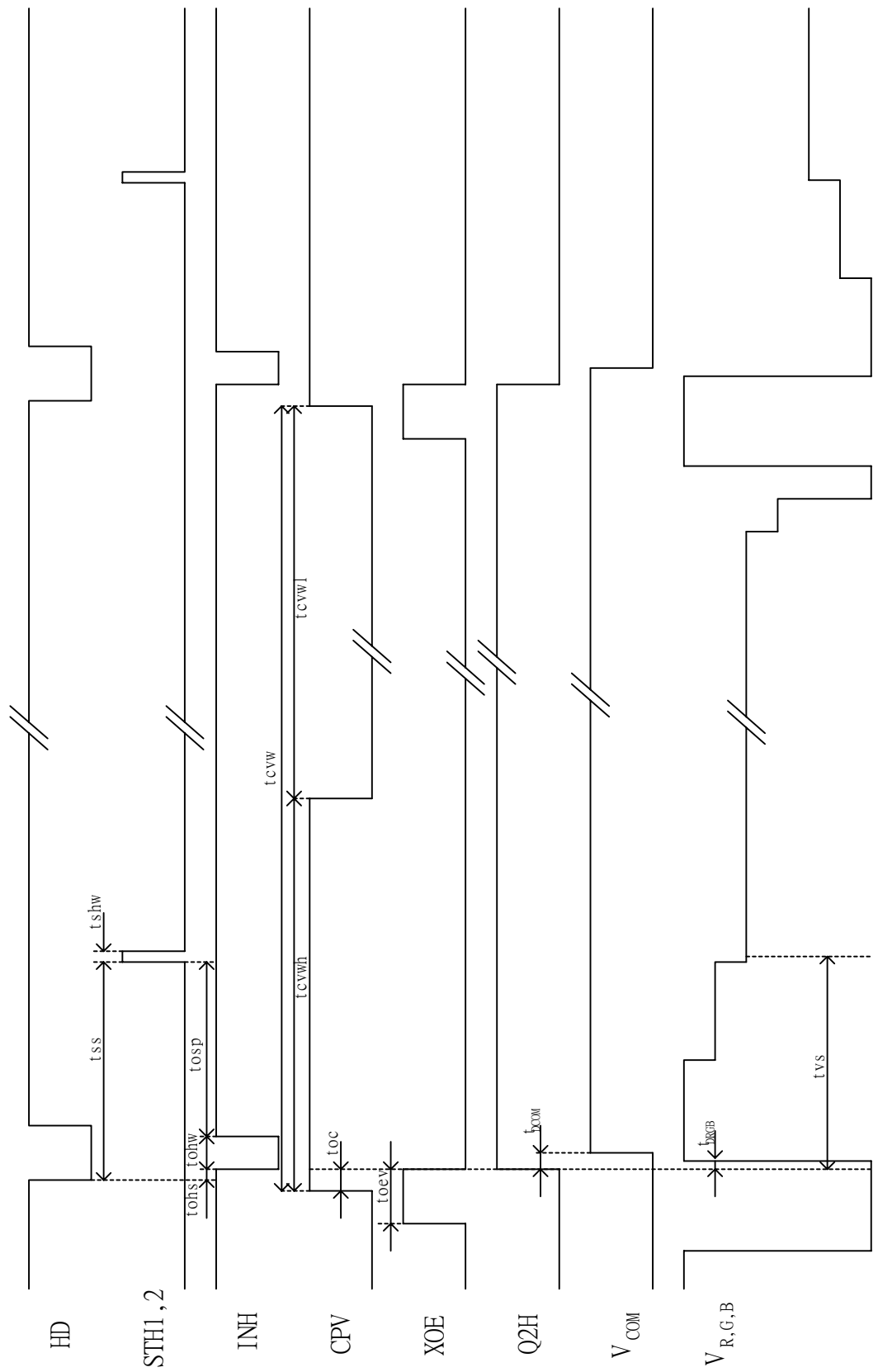

Fig. 8-3 Detail Horizontal Timing

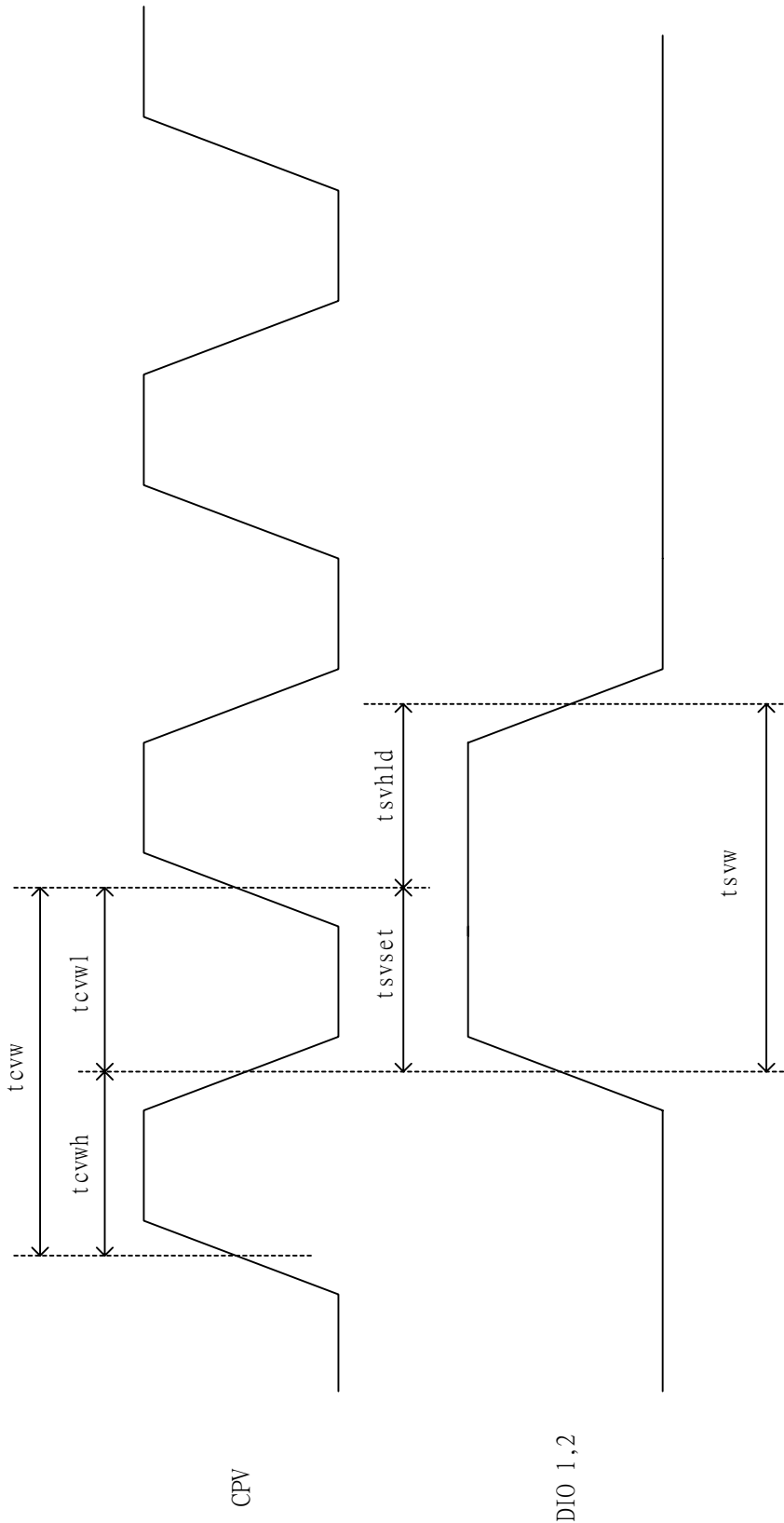

Fig. 8-5 Vertical Shift Clock Timing

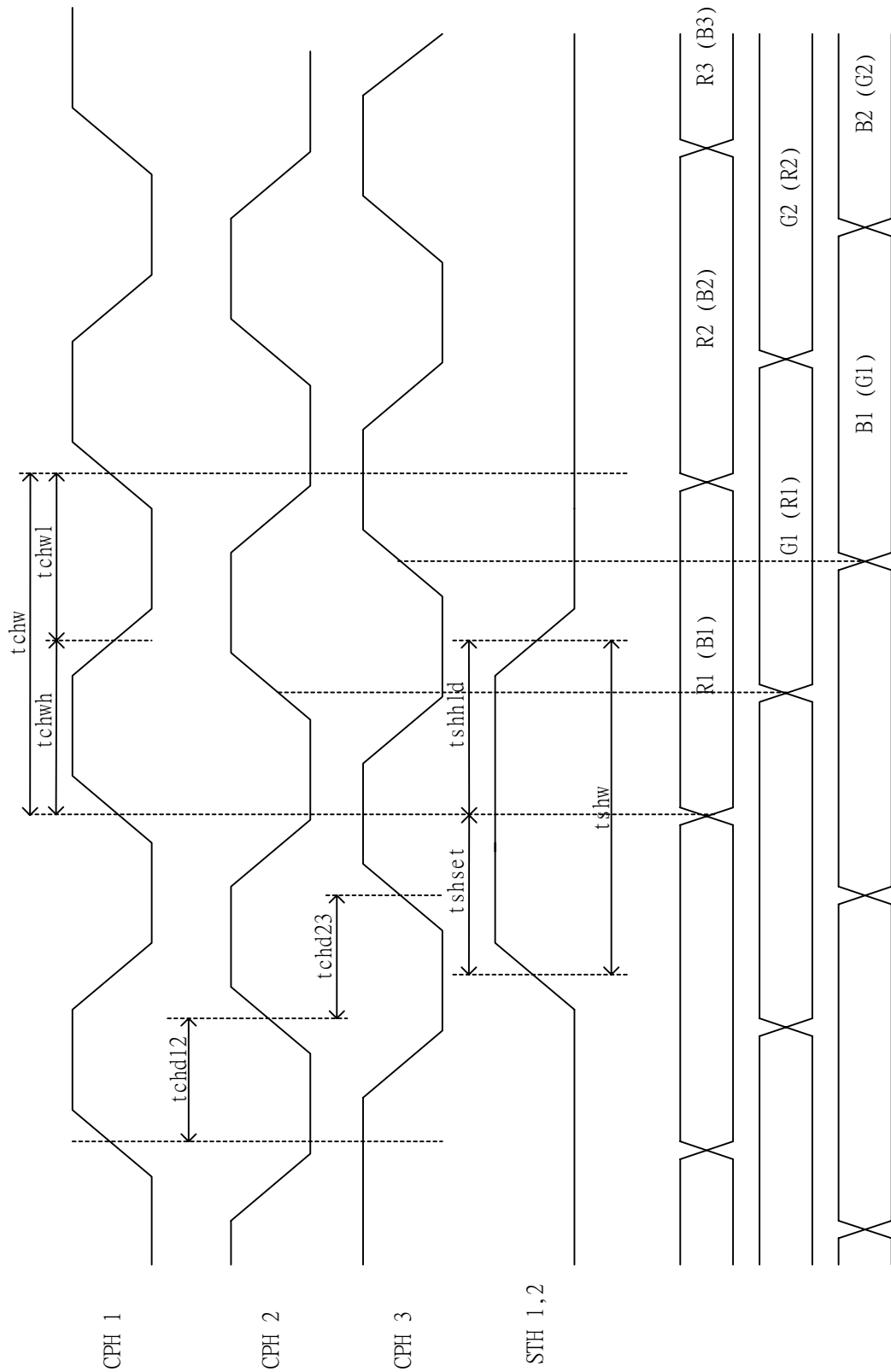

Fig. 8-4 Sampling Clock Timing

Vertical timing (From up to down)

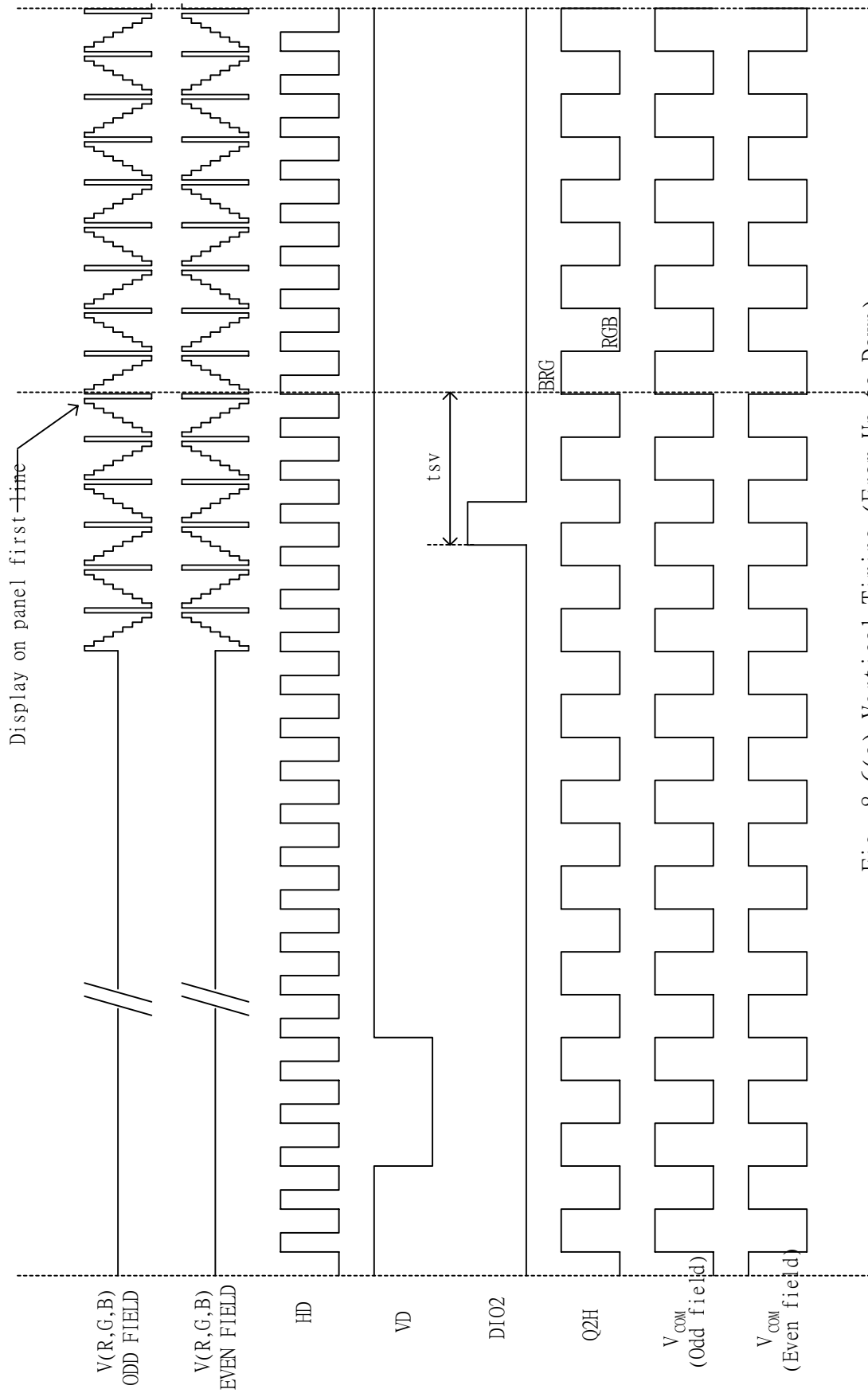

Fig. 8-6(a) Vertical Timing (From Up to Down)

Vertical timing (From down to up)

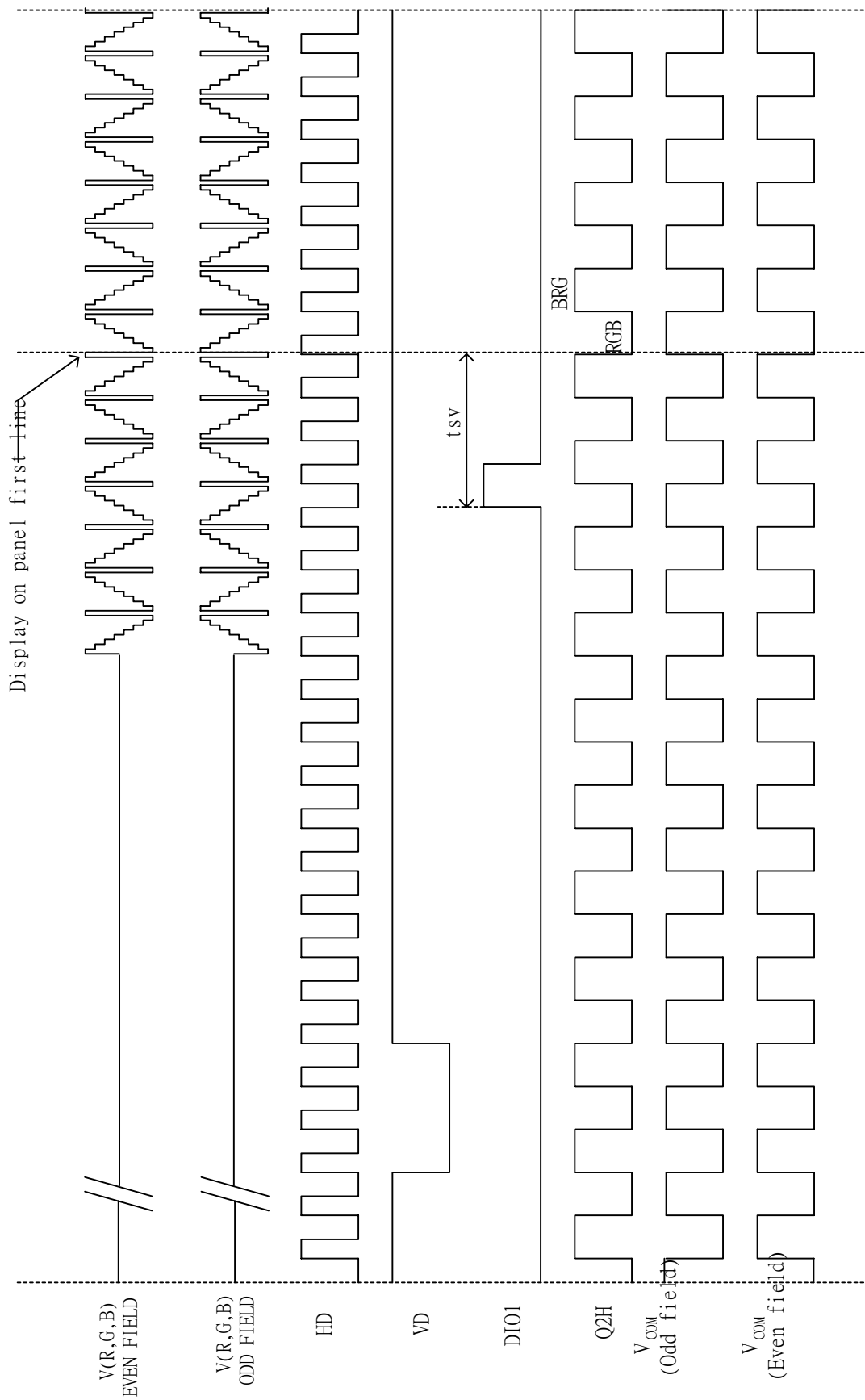
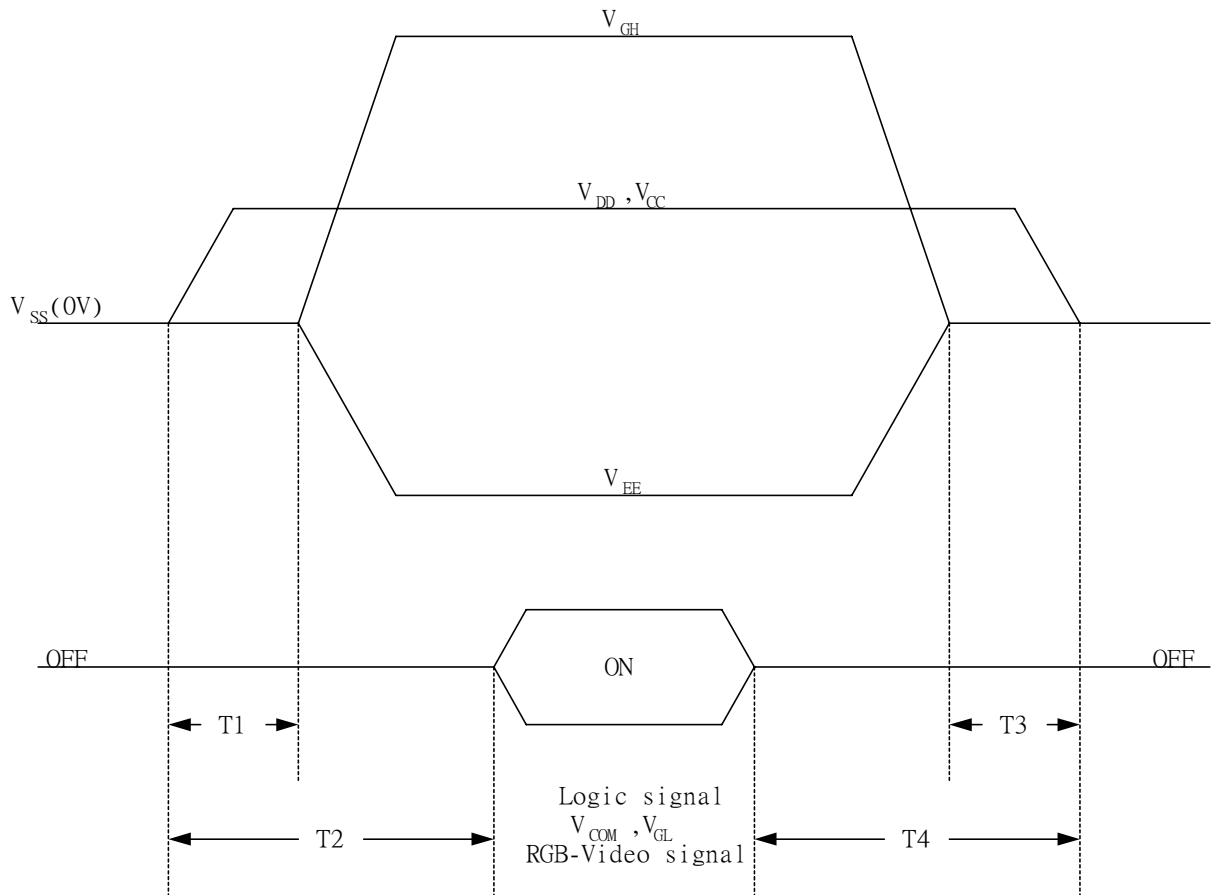

Fig. 8-6(b) Vertical Timing (From Down to Up)

9. Power Sequence(Voltage source)

The Power Sequence only effect by $V_{CC}, V_{SS}, V_{DD}, V_{EE}$ and V_{GH} , the others do not care.



$$10\text{ms} \leq T1 < T2$$

$$1) 0\text{ms} < T3 \leq T4 \leq 10\text{ms}$$

10. Optical Characteristics

10-1) Specification

$T_a = 25^\circ\text{C}$

Parameter	Symbol	Condition	MIN.	TYP.	MAX.	Unit	Remarks	
Viewing Angle	Horizontal	$CR \geq 10$	± 45	± 50		deg	Note 10-3	
	Vertical		(to 12 o'clock)	10	15			deg
			(to 6 o'clock)	30	35			deg
Contrast Ratio	CR		110	150			Note 10-1	
Response time	Rise	$=0^\circ$			30	ms	Note 10-4	
	Fall	$=0^\circ$			50	ms		
Transmission Ratio	R		7.4	8	8.5	%		
Brightness			200	250		cd/m ²	Note 10-2	
White Chromaticity	X	$=0^\circ$	0.250	0.300	0.350		Note 10-2	
	y		0.260	0.310	0.360			
Lamp Life Time	+25		10,000			hr		

Note 10-1 : $CR = \frac{\text{Luminance when LCD is White}}{\text{Luminance when LCD is Black}}$

Contrast Ratio is measured in optimum common electrode voltage.

The test configurations of contrast ratio see section 10-2.

- Note 10-2 : 1.Topcon BM-7(fast) luminance meter 1 field of view is used in the testing (after 20~30 minutes operation).
 2.Lamp current : 3 mA
 3.Inverter model : TDK-347.

Note 10-3 : The definition of viewing angle diagrams :

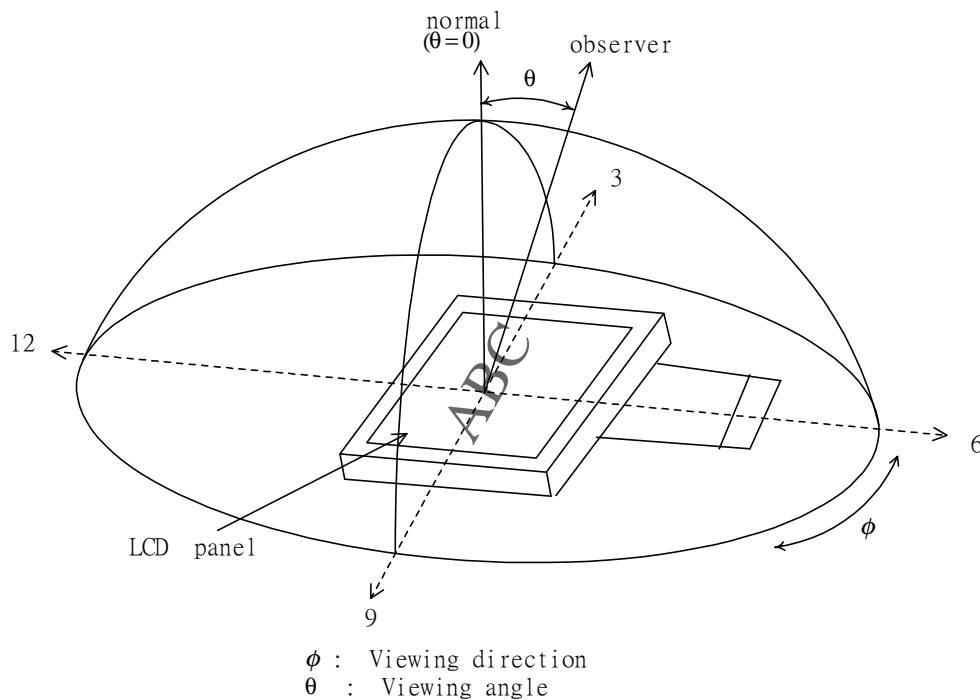

Note 10-4 : The definitions of response time:

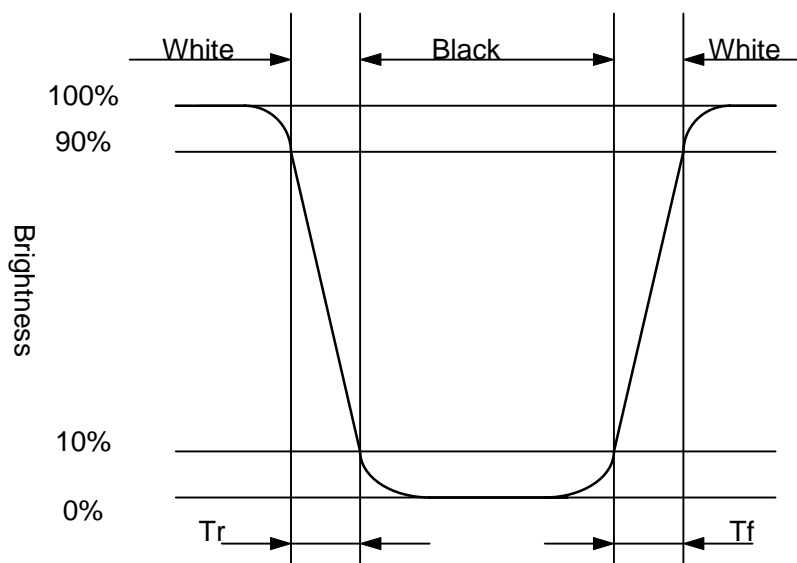

10-2) Test Configuration

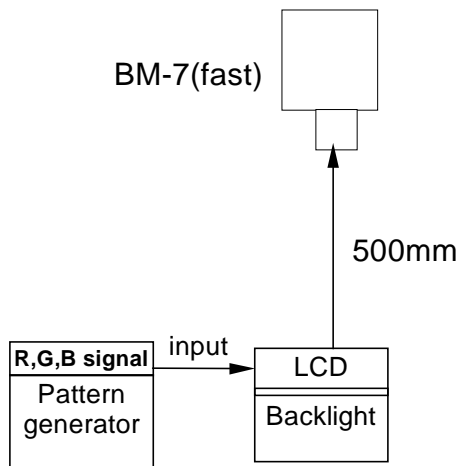

Caution: 1. Environmental illumination ≤ 1 lux
2. Before test CR, Vcom voltage must be adjusted carefully to get the best CR.

- LCD Display

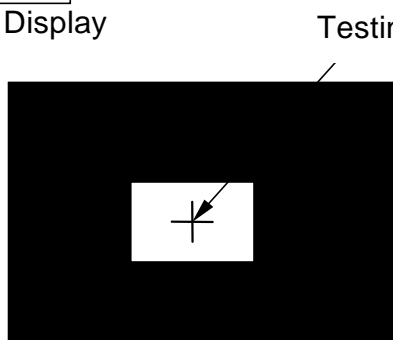

Pattern A

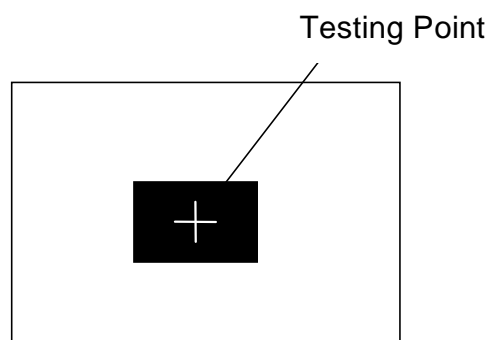

Pattern B

- R, G, B Waveform of Pattern A at Testing Point

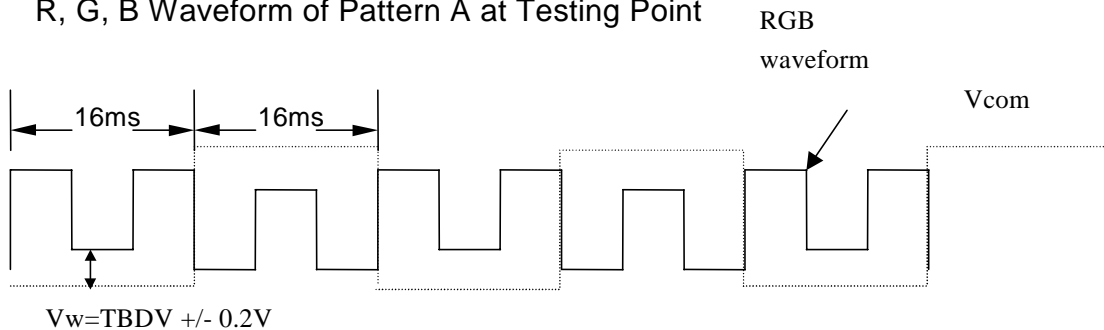

- R, G, B Waveform of Pattern B at Testing Point

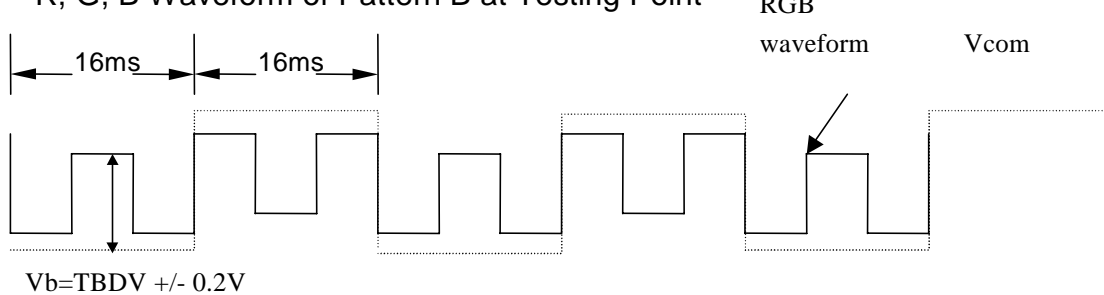

11. Handling Cautions

11-1) Mounting of module

- a) Please power off the module when you connect the input/output connector.
- b) Please connect the ground pattern of the inverter circuit surely. If the connection is not perfect, some following problems may happen possibly.
 - 1. The noise from the backlight unit will increase.
 - 2. The output from inverter circuit will be unstable.
 - 3. In some cases a part of module will heat.
- c) Polarizer which is made of soft material and susceptible to flaw must be handled carefully.
- d) Protective film (Laminator) is applied on surface to protect it against scratches and dirt. It is recommended to peel off the laminator before use and taking care of static electricity.

11-2) Precautions in mounting

- a) When metal part of the TFT-LCD module (shielding lid and rear case) is soiled, wipe it with soft dry cloth.
- b) Wipe off water drops or finger grease immediately. Long contact with water may cause discoloration or spots.
- c) TFT-LCD module uses glass which breaks or cracks easily if dropped or bumped on hard surface. Please handle with care.
- d) Since CMOS LSI is used in the module. So take care of static electricity and earth yourself when handling.

11-3) Others

- a) Do not expose the module to direct sunlight or intensive ultraviolet rays for many Hours.
- b) Store the module at a room temperature place.
- a) The voltage of beginning electric discharge may over the normal voltage because of leakage current from approach conductor by to draw lump read lead line around.
- b) If LCD panel breaks, it is possibly that the liquid crystal escapes from the panel.
Avoid putting it into eyes or mouth. When liquid crystal sticks on hands, clothes or feet. Wash it out immediately with soap.
- c) Observe all other precautionary requirements in handling general electronic components.
- d) Please adjust the voltage of common electrode as material of attachment by 1 module.

12. Reliability

No.	Test Item	Test Condition
1	High Temperature Storage Test	Ta = +70 °C, 240 hrs
2	Low Temperature Storage Test	Ta = -20 °C, 240 hrs
3	Low Temperature Operation Test	Ta = 0 °C, 240 hrs
4	High Temperature & High Humidity Operation Test	Ta = +60 °C, 95%RH, 240 hrs
5	Thermal Cycling Test (non-operating)	-25 °C → +25 °C → +70 °C, 200 Cycles 30 min 5min 30 min
6	Vibration Test (non-operating)	Frequency : 10 ~ 55 Hz Amplitude : 1.0 mm Sweep time: 11 mins Test Period: 6 Cycles for each direction of X, Y, Z
7	Shock Test (non-operating)	100G, 6ms Direction: ±X, ±Y, ±Z Cycle: 3 times
8	Electrostatic Discharge Test (non-operating)	150pF, 330 Ω Air: ±15KV; Contact: ±8KV 10 times/point, 4 points/panel face

Ta: ambient temperature

[Criteria]

Under the display quality test conditions with normal operation state, there should be no change which may affect practical display function.

13. Indication of Lot Number Label

a) Indicated contents of the label

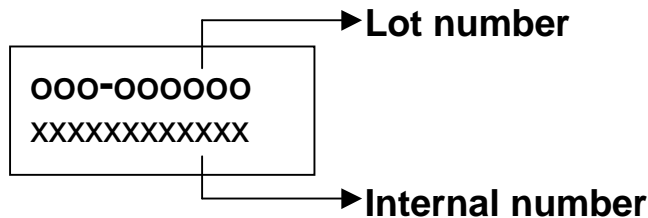

Contents of lot number : SB9—STC OEM product

5th—Production year : 1999⇒9, 2000⇒A, 2001⇒1.....

6th—Production month : 1, 2, 3,....9, A, B, C

7th~10th—Serial numbers : 0001~9999

14. Block Diagram

