

<p style="text-align: center;"><b>TECHNICAL SPECIFICATION</b></p> <p style="text-align: center;"><b>MODEL NO.: PD104SL3</b></p>
---

Customer's Confirmation

Customer Name \_\_\_\_\_

Date \_\_\_\_\_

By \_\_\_\_\_

PVI's Confirmation

Confirmed By \_\_\_\_\_

Prepared By \_\_\_\_\_

**FOR MORE INFORMATION:**  
AZ DISPLAYS, INC.  
75 COLUMBIA, ALISO VIEJO, CA, 92656  
[Http://www.AZDISPLAYS.com](http://www.AZDISPLAYS.com)

Date: Jan.10, 2005

This technical specification is subject to change without notice.  
Please contact with PVI for more detail information about this specification sheet.

---

**TECHNICAL SPECIFICATION****CONTENTS**

<b><i>NO.</i></b>	<b><i>ITEM</i></b>	<b><i>PAGE</i></b>
-	Cover	1
-	Contents	2
1	Application	3
2	Features	3
3	Mechanical Specifications	3
4	Mechanical Drawing of TFT-LCD module	4
5	Input / Output Terminals	5
6	Absolute Maximum Ratings	7
7	Electrical Characteristics	7
8	Power On Sequence	13
9	Optical Characteristics	14
10	Handling Cautions	17
11	Reliability Test	18
12	Block Diagram	19
13	Packing	20
-	Revision History	21

### 1. Application

This data sheet applies to a color TFT LCD module, PD104SL3.

PD104SL3 module applies to notebook PC, sub-note-book PC and other OA product, which require high quality flat panel display. **This module is not designed for aerospace, avionics, medical, F/A, transportation, car or any other products, which require extreme level of reliability.**

Prime View assume no responsibility for any damage resulting from the use of the device which dose not comply with the instructions and the precautions in these specification sheet.

### 2. Features

- . Amorphous silicon TFT LCD panel with back-light unit
- . Pixel in stripe configuration
- . Slim and compact, designed for O/A application
- . Display Colors : 262,144 colors
- . Optimum Viewing Direction : 6 o'clock
- . 3.3V LVDS interface standard: DS90CF364 as receiver
- . +3.3V DC supply voltage for TFT LCD panel driving
- . Backlight driving DC/AC inverter not included in this module
- . Long Life Lamp

### 3. Mechanical Specifications

Parameter	Specifications	Unit
Screen Size	26.4(diagonal)	cm
	10.4 (diagonal)	inch
Display Format	800×(R, G, B)×600	dot
Display Colors	262,144	
Active Area	211.2(H)×158.4 (V)	mm
Pixel Pitch	0.264 (H)×0.264 (V)	mm
Pixel Configuration	Stripe	
Outline Dimension	238.6 (w)×171.0(H)×6.0(typ.) (D)	mm
Weight	310(typ.),320(max.)	g
Back-light	Single CCFL, side-light type	
Surface treatment	Anti-glare and hard-coating	
Display mode	Normally white	

4. Mechanical Drawing of TFT-LCD Module

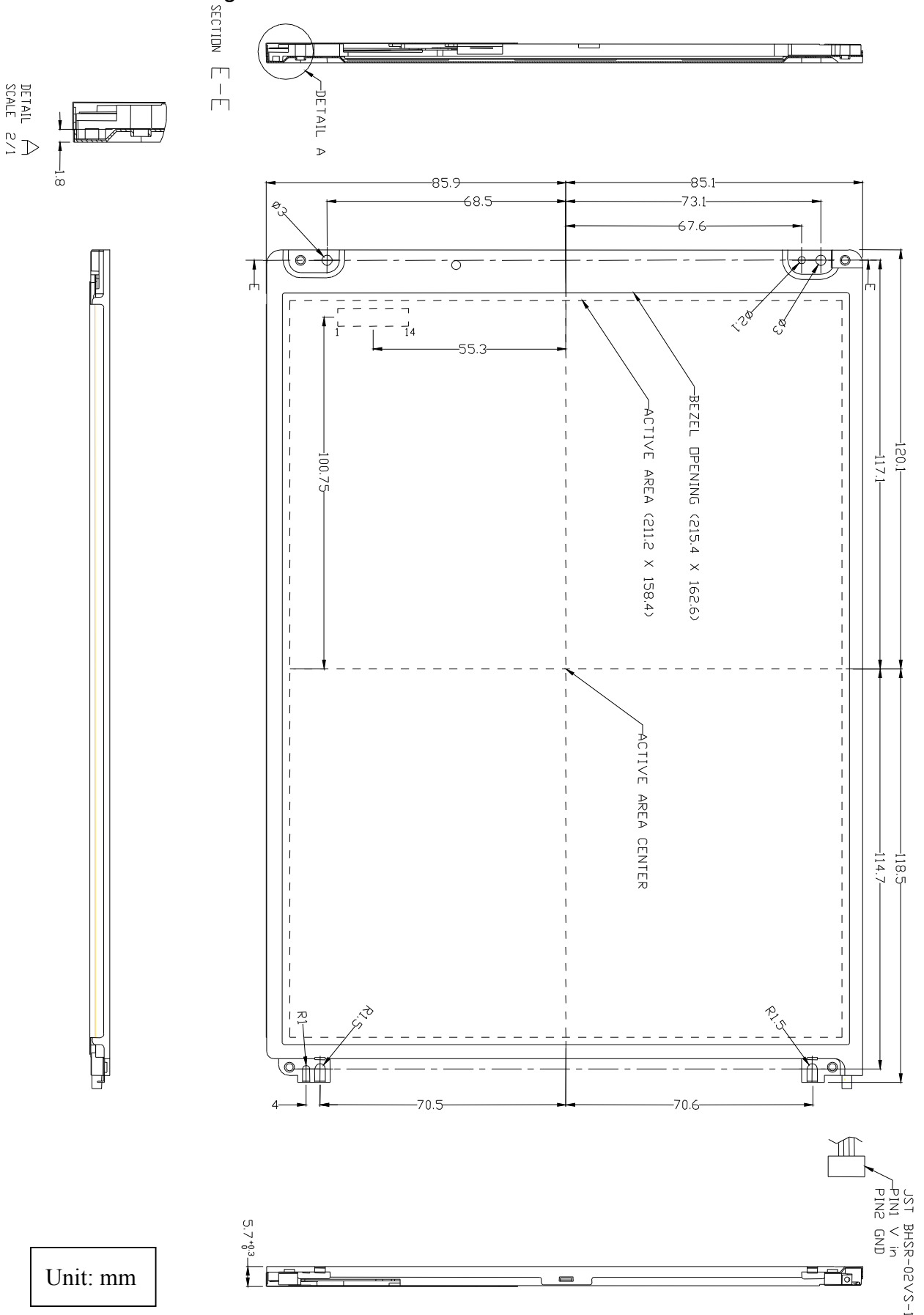

Unit: mm

5. Input Terminals

5-1) TFT-LCD Panel Driving

Connector type: Molex 55177-1491

Pin No.	Symbol	Function	Remark
1	VDD	Power supply : +3.3V	
2	VDD	Power supply : +3.3V	
3	GND		
4	GND		
5	IN0-	Pixel data Transmission pair 0 (negative -)	
6	IN0+	Pixel data Transmission pair 0 (positive +)	
7	IN1-	Pixel data Transmission pair 1 (negative -)	
8	IN1+	Pixel data Transmission pair 1 (positive +)	
9	IN2-	Pixel data Transmission pair 2 (negative -)	
10	IN2+	Pixel data Transmission pair 2 (positive +)	
11	CLK-	Sampling Clock (negative -)	
12	CLK+	Sampling Clock (positive +)	
13	GND		
14	GND		

Recommended Transmitter (DS90C\*363 of National Semiconductor) to PD104SL3 interface Assignment:

Input terminal of DS 90C*363		Graphic controller output signal		Output signal symbol	To PD104SL3 interface terminal(Symbol)
Symbol	No.	Symbol	Function		
TIN0	44	R0	Red pixel data (LSB)	Tout0- Tout0+	No.5 : IN0- No.6 : IN0+
TIN1	45	R1	Red pixel data		
TIN2	47	R2	Red pixel data		
TIN3	48	R3	Red pixel data		
TIN4	1	R4	Red pixel data		
TIN5	3	R5	Red pixel data(MSB)	Tout1- Tout1+	No.7 : IN1- No.8 : IN1+
TIN6	4	G0	Green pixel data (LSB)		
TIN7	6	G1	Green pixel data		
TIN8	7	G2	Green pixel data		
TIN9	9	G3	Green pixel data		
TIN10	10	G4	Green pixel data	Tout2- Tout2+	No.9 : IN2- No.10 : IN2+
TIN11	12	G5	Green pixel data(MSB)		
TIN12	13	B0	Blue pixel data(LSB)		
TIN13	15	B1	Blue pixel data		
TIN14	16	B2	Blue pixel data		
TIN15	18	B3	Blue pixel data	TCLK out- TCLK out+	No.11 : CLK IN- No.12 : CLK IN+
TIN16	19	B4	Blue pixel data		
TIN17	20	B5	Blue pixel data(MSB)		
TIN18	22	NC	No connection		
TIN19	23	NC	No connection		
TIN20	25	ENAB	Compound Synchronization signal		
CLK in	26	NCLK	Data sampling clock		

Data stream of IN0-/+, IN1-/+, and IN2-/+, for PD104SL3

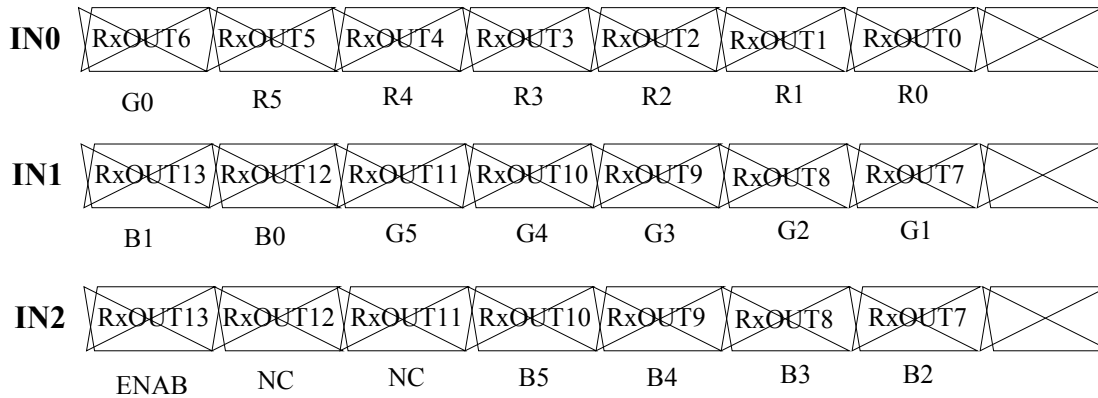

LVDS Interface Block Diagram

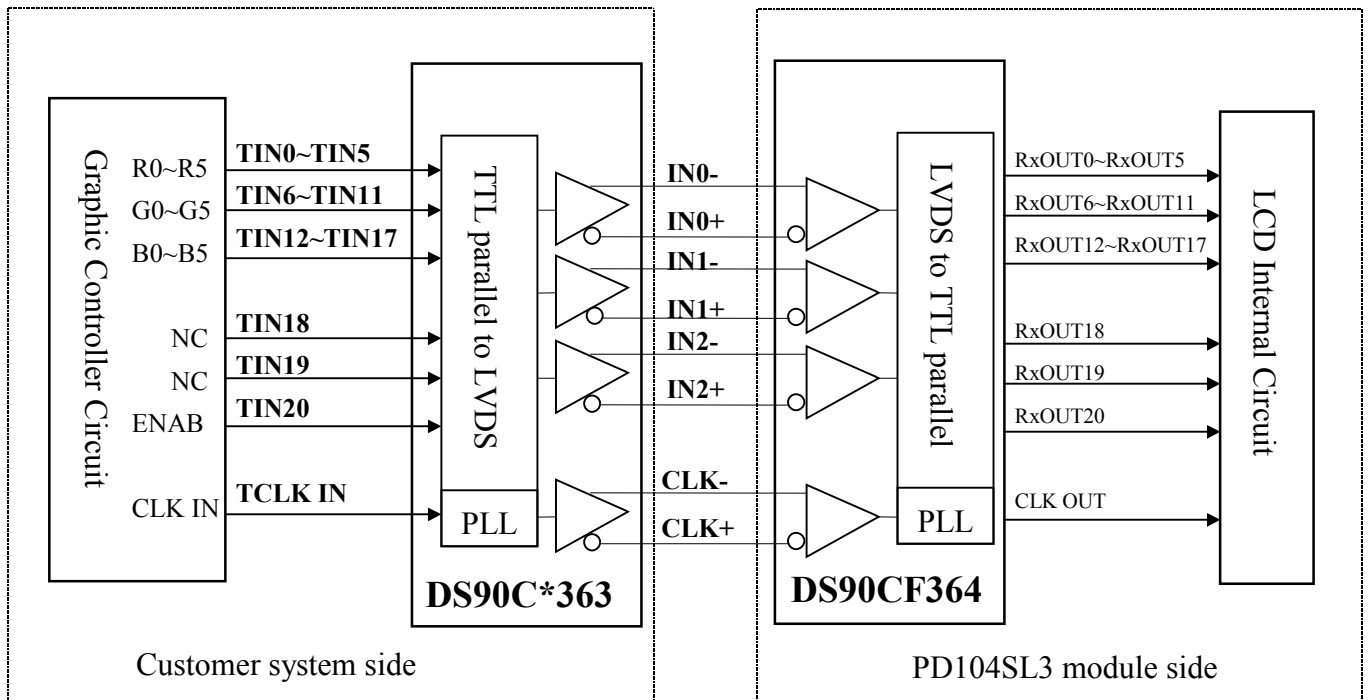

5-2) Backlight driving

Connector type : "BHR-02VS-1" of Japan Solderless Terminal MFG Co. LTD

PIN NO.	Symbol	Description	Remark
1	VL1	Input Voltage(High)	
2	VL2	Input Voltage(Low)	

6. Absolute Maximum Ratings:

GND=0V, Ta=25°C

Parameters	Symbol	MIN.	MAX.	Unit	Remark
Supply Voltage	VDD	-0.3	+4.0	V	
Input Signals Voltage	V <sub>IN</sub>	-0.3	VDD+0.3	V	Note 61
Backlight Driving Voltage	V <sub>L</sub>	-	2000	V	
Backlight Driving Frequency	F <sub>L</sub>	0	100	KHz	
Storage Temperature	T <sub>ST</sub>	-20	+70	°C	Note 62
Operating Temperature	T <sub>OP</sub>	0	+60	°C	

Note 6-1: LVDS signal

Note 6-2: Humidity : 90% RH Max. at Ta ≤ 40°C.

Maximum wet-bulb temperature is at 39°C or less at Ta > 40°C and no condensation.

7. Electrical Characteristics

7-1) Recommended Operating Conditions:

GND = 0V , Ta = 25°C

Item	Symbol	Min.	Typ.	Max.	Unit	Remark
Supply Voltage	VDD	3.0	3.3	3.6	V	
Current Dissipation	I <sub>DD</sub>	-	350	450	mA	Note 71
LVDS Differential input high threshold	V <sub>TH</sub>	-	-	100	mV	Note 72
LVDS Differential input low threshold	V <sub>TL</sub>	-100	-	-		
Lamp Current	I <sub>FL</sub>	3.0	5.0	7.0	mA	5mA : 160 cd/m <sup>2</sup> Note 73 Note 76
Lamp Voltage	V <sub>L</sub>	550	500	450	V <sub>rms</sub>	I <sub>FL</sub> =5mA Note 73
Kick-off voltage (Reference Value)	V <sub>SFL</sub>	-	-	1340	V <sub>rms</sub>	at Ta=25°C Note 74
		-	-	1750		at Ta=0°C
Lamp Driving Frequency	F <sub>L</sub>	45	60	80	KHz	
Total power consumption (at I <sub>FL</sub> =5mA)		--	3.6	-	W	Note 75

Note 7-1 : To test the current dissipation of VDD, using the “color bars” testing pattern shown as below

1	2	3	4	5	6	7	8
---	---	---	---	---	---	---	---

1. White
2. Yellow
3. Cyan
4. Green
5. Magenta
6. Red
7. Blue
8. Black

I<sub>DD</sub> current dissipation testing pattern

Note 7-2 : Please refers to DS90CF364 specification by National Semiconductor Corporation.  
This LCD module conforms to LVDS standard.

Note 7-3 : The back-light driving waveform should be as closed to sine-wave as possible.  
In order to satisfy the quality of B/L , no matter use what kind of inverter , the output lamp current must between Min. and Max. to avoid the abnormal display image caused by B/L.

Note 7-4 : The kick-off times  $\geq 1$ sec.

Note 75 : Not including the efficiency of backlight DC/AC inverter

Note 76 : Lamp current is measured with current meter for high frequency as shown below

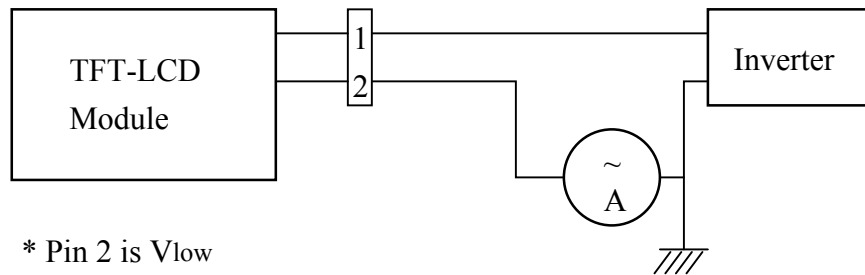

\* Pin 2 is Vlow  
\*\* Current meter :  
Yokogawa 2016-01

Lamp current dissipation testing configuration

7-2) Input / Output signal timing chart

(A) Vertical Timing

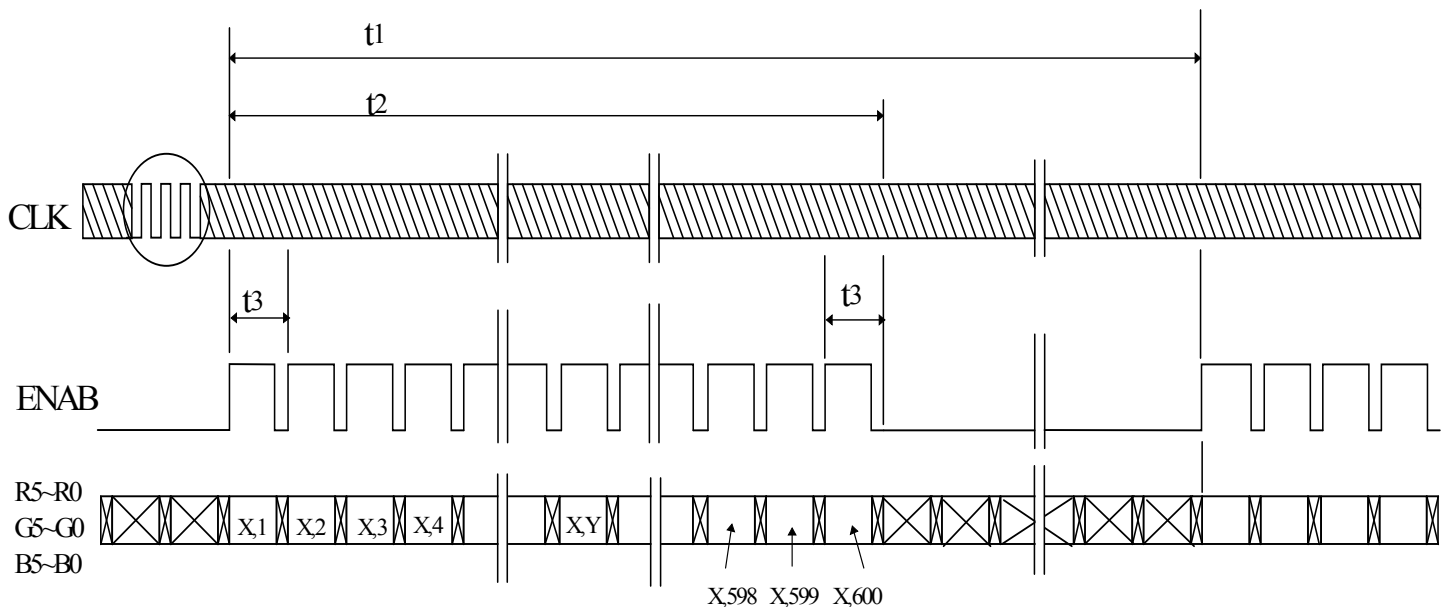



(B) Horizontal Timing

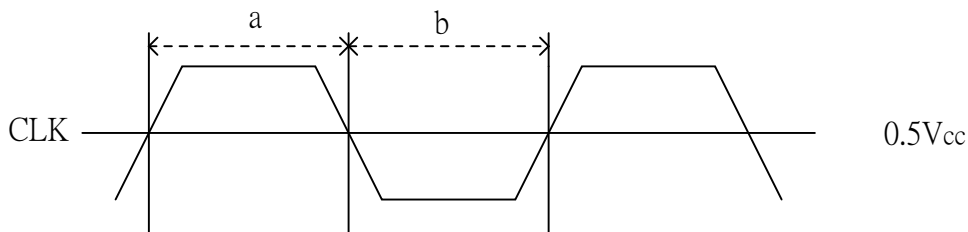
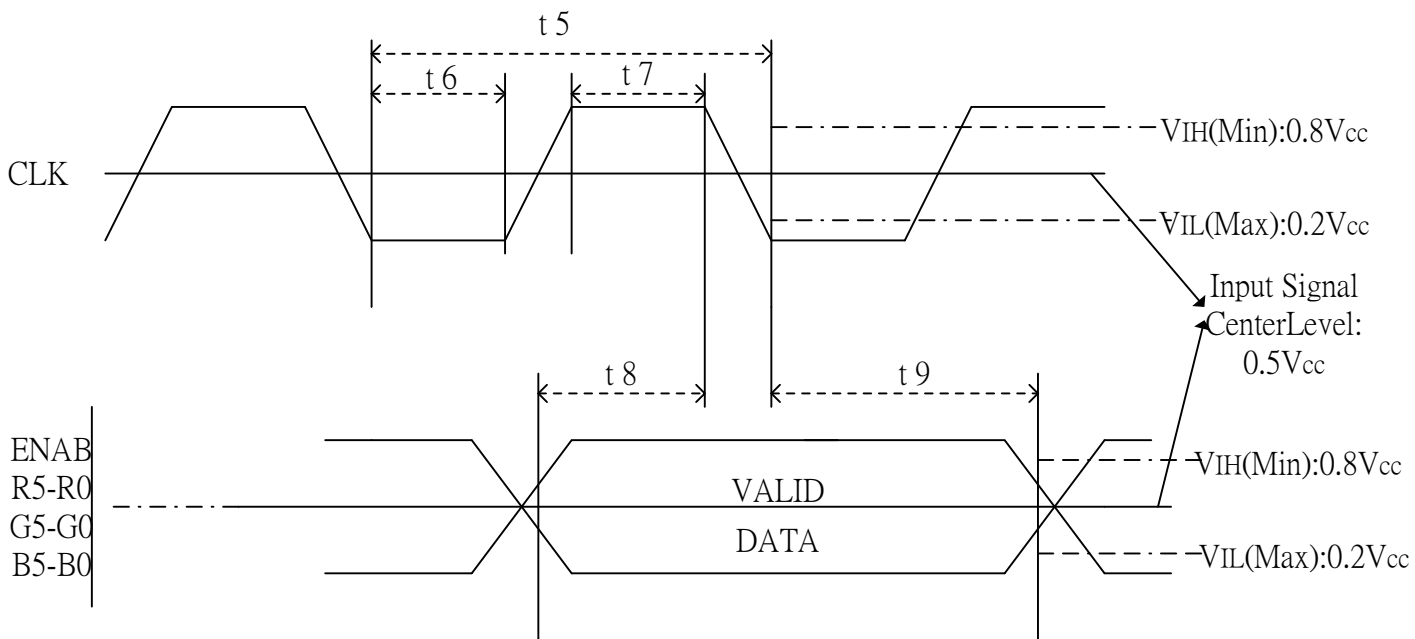
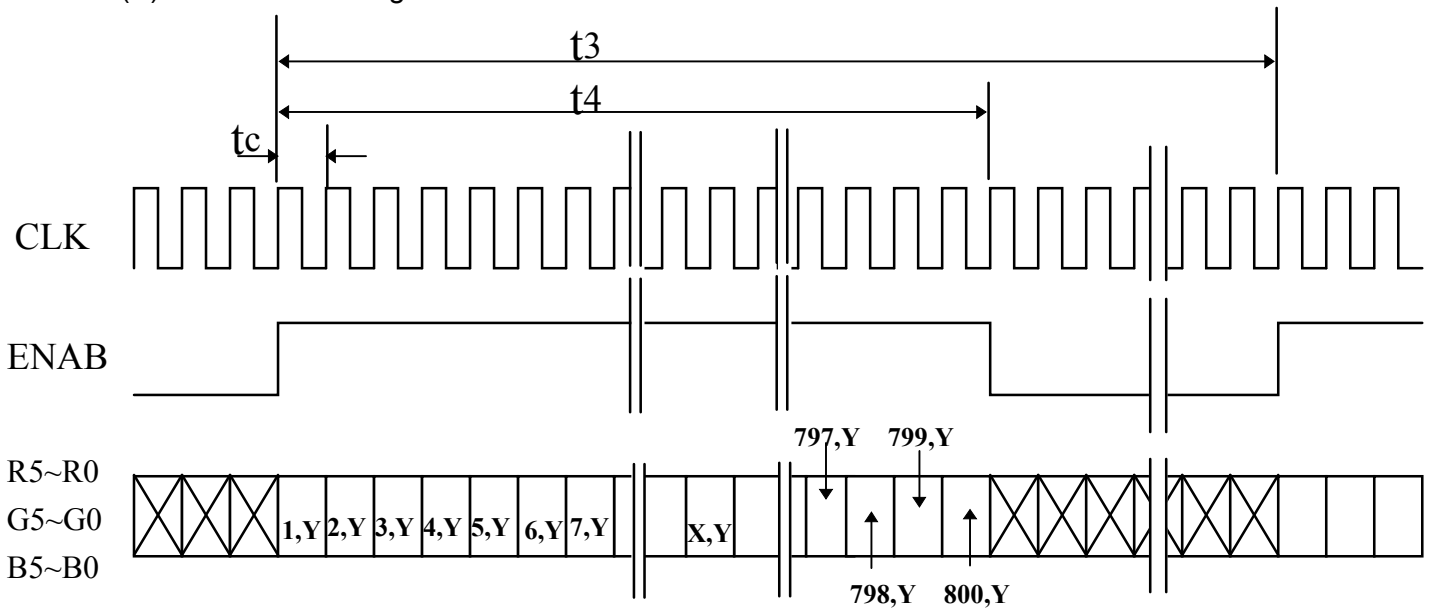

Duty ( a , b ) :  $50 \pm 10\%$

D) Timing Specifications

Item	Symbol	Min.	Typ.	Max.	Unit	Remark
Frame Cycling	t1	604 X t3	628X t3	800 X t3	-	
		-	16.58		ms	
Vertical Display Period	t2	600 X t3	600 X t3	600 X t3	-	
Horizontal Scanning Time	t3	920 X t5	1056 X t5	1064 X t5	-	
			26.4	-	$\mu$ s	
Horizontal Display Period	t4	-	800 X t5	-	-	
Clock Cycle	t5		25.0	-	ns	
Clock High Level Time	t6	9.0	-	-	ns	
Clock Low Level Time	t7	9.0	-	-	ns	
Hold time	t8	4.0	-	-	ns	
Set-up time	t9	5.0	-	-	ns	

7-3) Display Color and Gray Scale Reference

Color		Input Color Data																	
		Red					Green					Blue							
		R5	R4	R3	R2	R1	R0	G5	G4	G3	G2	G1	G0	B5	B4	B3	B2	B1	B0
Basic Colors	Black	0	0	0	0	0	0	0	0	0	0	0	0	0	0	0	0	0	0
	Red (63)	1	1	1	1	1	1	0	0	0	0	0	0	0	0	0	0	0	0
	Green (63)	0	0	0	0	0	0	1	1	1	1	1	1	0	0	0	0	0	0
	Blue (63)	0	0	0	0	0	0	0	0	0	0	0	0	1	1	1	1	1	1
	Cyan	0	0	0	0	0	0	1	1	1	1	1	1	1	1	1	1	1	1
	Magenta	1	1	1	1	1	1	0	0	0	0	0	0	1	1	1	1	1	1
	Yellow	1	1	1	1	1	1	1	1	1	1	1	1	0	0	0	0	0	0
	White	1	1	1	1	1	1	1	1	1	1	1	1	1	1	1	1	1	1
Red	Red (00)	0	0	0	0	0	0	0	0	0	0	0	0	0	0	0	0	0	0
	Red (01)	0	0	0	0	0	1	0	0	0	0	0	0	0	0	0	0	0	0
	Red (02)	0	0	0	0	1	0	0	0	0	0	0	0	0	0	0	0	0	0
	Darker																		
	↓	↓	↓	↓	↓	↓	↓	↓	↓	↓	↓	↓	↓	↓	↓	↓	↓	↓	↓
	Brighter																		
	Red (61)	1	1	1	1	0	1	0	0	0	0	0	0	0	0	0	0	0	0
	Red (62)	1	1	1	1	1	0	0	0	0	0	0	0	0	0	0	0	0	0
Red (63)	1	1	1	1	1	1	0	0	0	0	0	0	0	0	0	0	0	0	
Green	Green (00)	0	0	0	0	0	0	0	0	0	0	0	0	0	0	0	0	0	0
	Green (01)	0	0	0	0	0	0	0	0	0	0	0	1	0	0	0	0	0	0
	Green (02)	0	0	0	0	0	0	0	0	0	0	1	0	0	0	0	0	0	0
	Darker																		
	↓	↓	↓	↓	↓	↓	↓	↓	↓	↓	↓	↓	↓	↓	↓	↓	↓	↓	↓
	Brighter																		
	Green (61)	0	0	0	0	0	0	1	1	1	1	0	1	0	0	0	0	0	0
	Green (62)	0	0	0	0	0	0	1	1	1	1	1	0	0	0	0	0	0	0
Green (63)	0	0	0	0	0	0	1	1	1	1	1	1	0	0	0	0	0	0	
Blue	Blue (00)	0	0	0	0	0	0	0	0	0	0	0	0	0	0	0	0	0	0
	Blue (01)	0	0	0	0	0	0	0	0	0	0	0	0	0	0	0	0	0	1
	Blue (02)	0	0	0	0	0	0	0	0	0	0	0	0	0	0	0	0	1	0
	Darker																		
	↓	↓	↓	↓	↓	↓	↓	↓	↓	↓	↓	↓	↓	↓	↓	↓	↓	↓	↓
	Brighter																		
	Blue (61)	0	0	0	0	0	0	0	0	0	0	0	0	1	1	1	1	0	1
	Blue (62)	0	0	0	0	0	0	0	0	0	0	0	0	1	1	1	1	1	0
Blue (63)	0	0	0	0	0	0	0	0	0	0	0	0	1	1	1	1	1	1	

7-4) Pixel Arrangement

The LCD module pixel arrangement is the stripe.

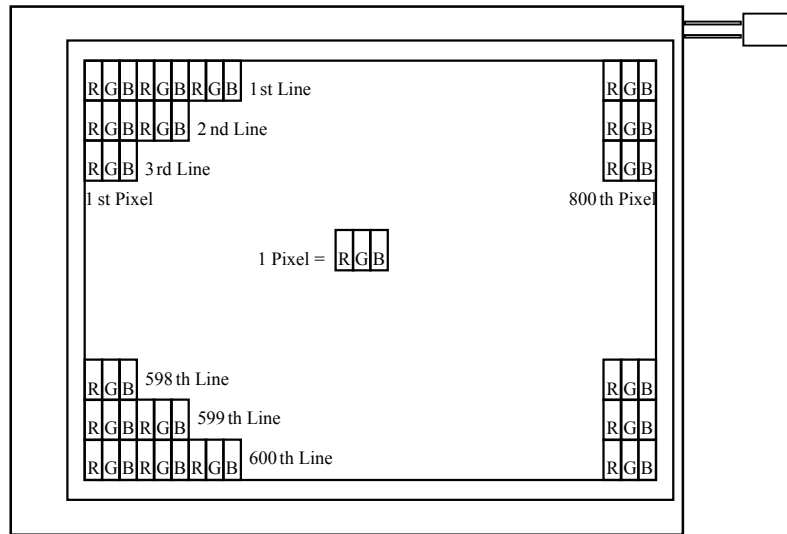

8.)Power On Sequence

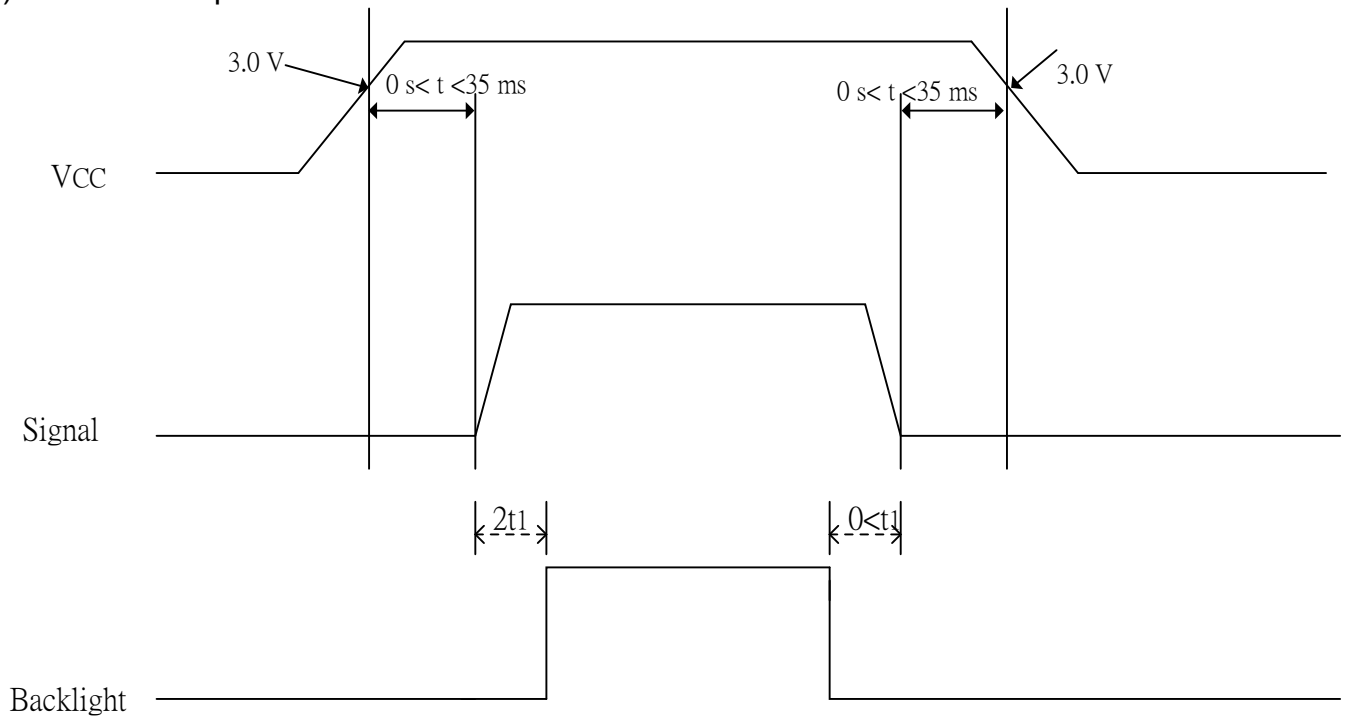

1. The supply voltage for input signals should be same as  $V_{CC}$ .
2. When the power is off , please keep whole signals (Hsync, Vsync, CLK, Data) low level or high impedance

9.) Optical Characteristics

9-1) Specification:

Ta = 25°C

Parameter		Symbol	Condition	MIN.	TYP.	MAX.	Unit	Remarks
Viewing Angle	Horizontal	$\theta$	CR $\geq$ 10	$\pm 35$	$\pm 45$	-	deg	
	Vertical	$\theta$ (to 12 o'clock)		10	15	-	deg	Note 91
		$\theta$ (to 6 o'clock)		25	40	-	deg	
Contrast Ratio		CR	Optimum direction	200	400	-	-	Note 92
Response time	Rise	Tr	$\theta = 0^\circ$	-	15	50	ms	Note 94
	Fall	Tf	$\varphi = 0^\circ$	-	25	50	ms	
Luminance		L	$\theta = 0^\circ / \varphi = 0^\circ$	130	160	-	cd/m <sup>2</sup>	I <sub>FL</sub> =5mA, Note 9-3
Luminance Uniformity		U		55	80	-	%	Note 95
White Chromaticity		x		0.29	0.32	0.35	-	
		y		0.32	0.35	0.38	-	
Lamp Life Time				30000	40000	-	hr	I <sub>FL</sub> =5mA
Cross Talk Ratio		CTK		-	-	3.5	%	Note 96

All the optical measurement shall be executed 30 minutes after backlight being turn-on. The optical characteristics shall be measured in dark room (ambient illumination on panel surface less than 1 Lux). The measuring configuration shows as following figure.

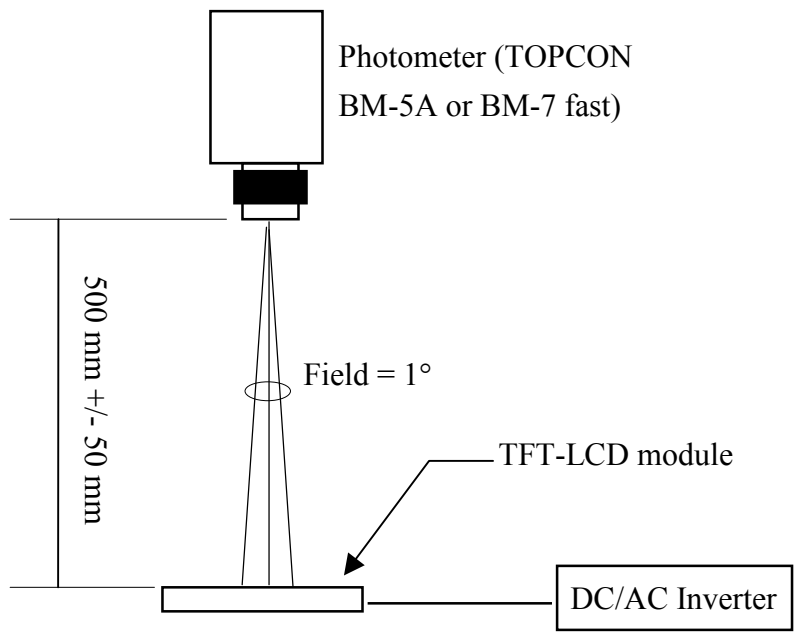

Optical characteristics measuring configuration

Note 9-1 : The definitions of viewing angles are as follows.

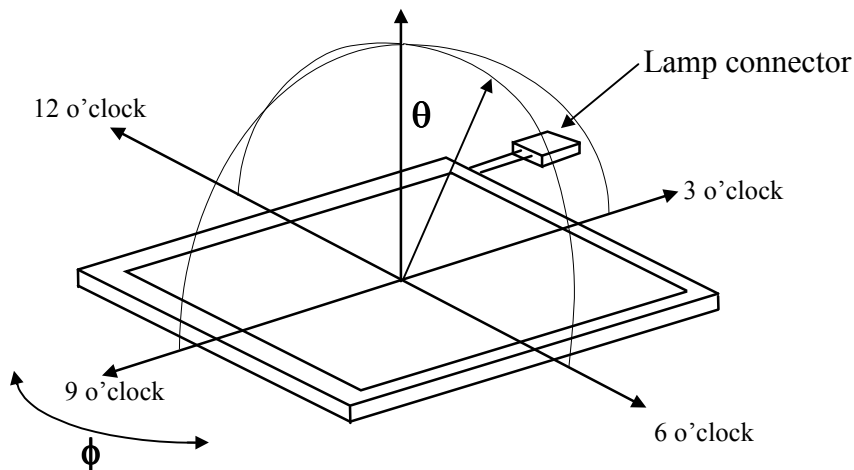

Note 9-2 : The definition of contrast ratio  $CR = \frac{\text{Luminance at gray level 63}}{\text{Luminance at gray level 0}}$

Note 9-3 : Topcon BM-5A luminance meter 1° field of view is used in the testing (after 30 minutes' operation). The typical luminance value is measured at lamp current 5.0 mA.

Note 9-4: Definition of Response Time  $T_r$  and  $T_f$ :

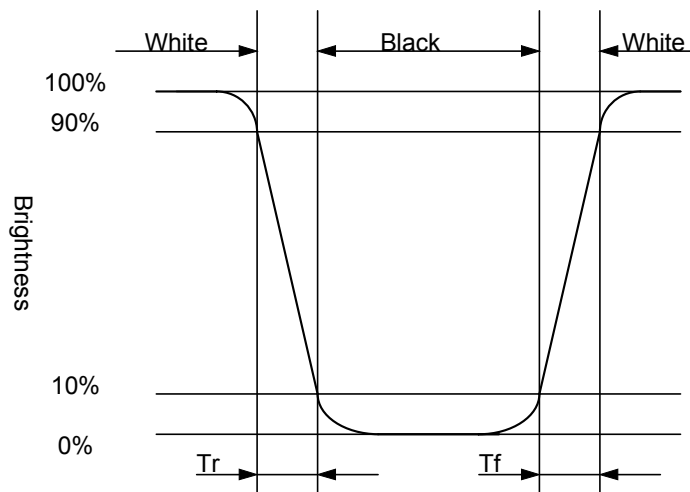

Note 9-5: The uniformity of LCD is defined as

$$U = \frac{\text{The Minimum Brightness of the 9 testing Points}}{\text{The Maximum Brightness of the 9 testing Points}}$$

Luminance meter : BM-5A or BM-7 fast(TOPCON)

Measurement distance : 500 mm +/- 50 mm

Ambient illumination : < 1 Lux

Measuring direction : Perpendicular to the surface of module

The test pattern is white (Gray Level 63).

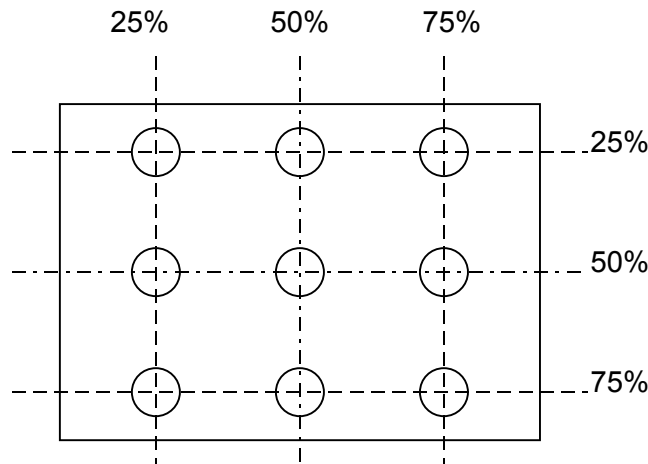

Note 9-6: Cross Talk (CTK) =  $\frac{|YA-YB|}{YA} \times 100\%$

YA: Brightness of Pattern A

YB: Brightness of Pattern B

Luminance meter : BM 5A (TOPCON)

Measurement distance : 500 mm +/- 50 mm

Ambient illumination : < 1 Lux

Measuring direction : Perpendicular to the surface of module

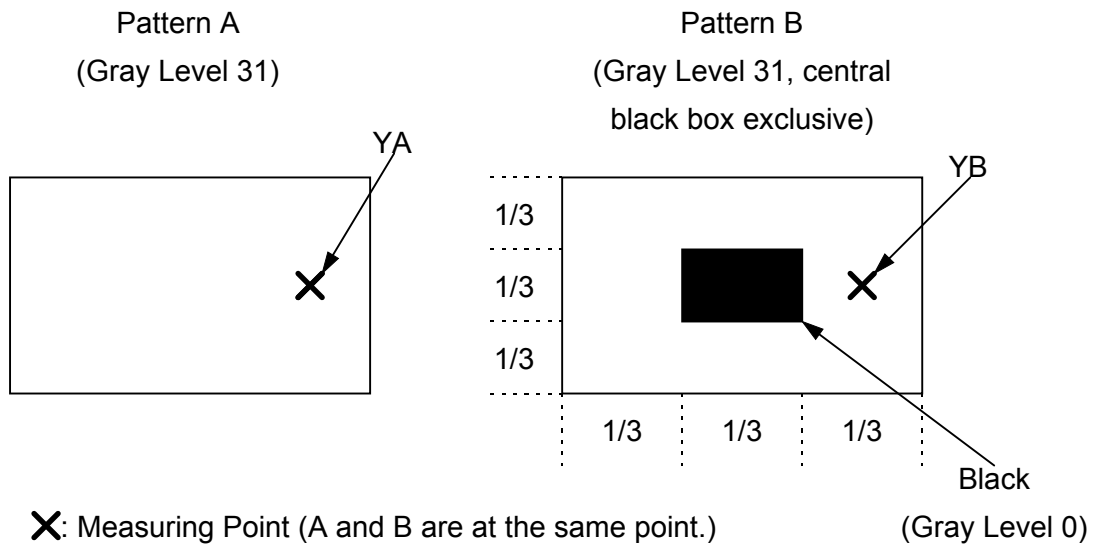



## 10. Handling Cautions

### 10-1) Mounting of module

1. Please power off the module when you connect the input/output connector.
- b) Please connect the ground pattern of the inverter circuit surely. If the connection is not perfect, some following problems may happen possibly.
  1. The noise from the backlight unit will increase.
  2. The output from inverter circuit will be unstable.
  3. In some cases a part of module will heat.
- c) Polarizer which is made of soft material and susceptible to flaw must be handled carefully.
- d) Protective film (Laminator) is applied on surface to protect it against scratches and dirt. It is recommended to peel off the laminator before use and taking care of static electricity.

### 10-2) Precautions in mounting

- a) When metal part of the TFT-LCD module (shielding lid and rear case) is soiled, wipe it with soft dry cloth.
- b) Wipe off water drops or finger grease immediately. Long contact with water may cause discoloration or spots.
- c) TFT-LCD module uses glass which breaks or cracks easily if dropped or bumped on hard surface. Please handle with care.
- d) Since CMOS LSI is used in the module. So take care of static electricity and earth yourself when handling.

### 10-3) Adjusting module

- a) Adjusting volumes on the rear face of the module have been set optimally before shipment.
- b) Therefore, do not change any adjusted values. If adjusted values are changed, the specifications described may not be satisfied.

### 10-4) Others

- a) Do not expose the module to direct sunlight or intensive ultraviolet rays for many hours.
- b) Store the module at a room temperature place.
- c) The voltage of beginning electric discharge may over the normal voltage because of leakage current from approach conductor by to draw lump read lead line around.
- d) If LCD panel breaks, it is possibly that the liquid crystal escapes from the panel. Avoid putting it into eyes or mouth. When liquid crystal sticks on hands, clothes or feet. Wash it out immediately with soap.
- e) Observe all other precautionary requirements in handling general electronic components.
- f) Please adjust the voltage of common electrode as material of attachment by 1 module.

11. Reliability Test

No	Test Item	Test Condition	Remark
1	High Temperature Storage Test	Ta = +70°C, 240 hrs	
2	Low Temperature Storage Test	Ta = -20°C, 240 hrs	
3	Low Temperature Operation Test	Ta = 0°C, 240 hrs	
4	High Temperature & High Humidity Operation Test	Ta = +60°C, 80%RH, 240 hrs (No Condensation)	
5	Thermal Cycling Test (non-operating)	0°C ←→ +60°C, 100 Cycles 1Hr      1Hr	
6	Vibration Test (non-operating)	Frequency : 10 ~ 57 Hz, Amplitude : 0.15 mm 58~500Hz, 1G Sweep time: 11 min Test Period: 3 hrs (1 hr for each direction of X, Y, Z)	
7	Shock Test (non-operating)	80G, 6ms, X,Y, Z 1 times for each direction	
8	Electron Static Discharge	C=150pF,R=330Ω Contact=±8KV Air=±15KV 10 times/terminal	

Ta: ambient temperature

Note : The protective film must be removed before temperature test.

[Judgments Criteria]

Under the display quality test conditions with normal operation state , there should be no change which may affect practical display function.

12.)Block Diagram

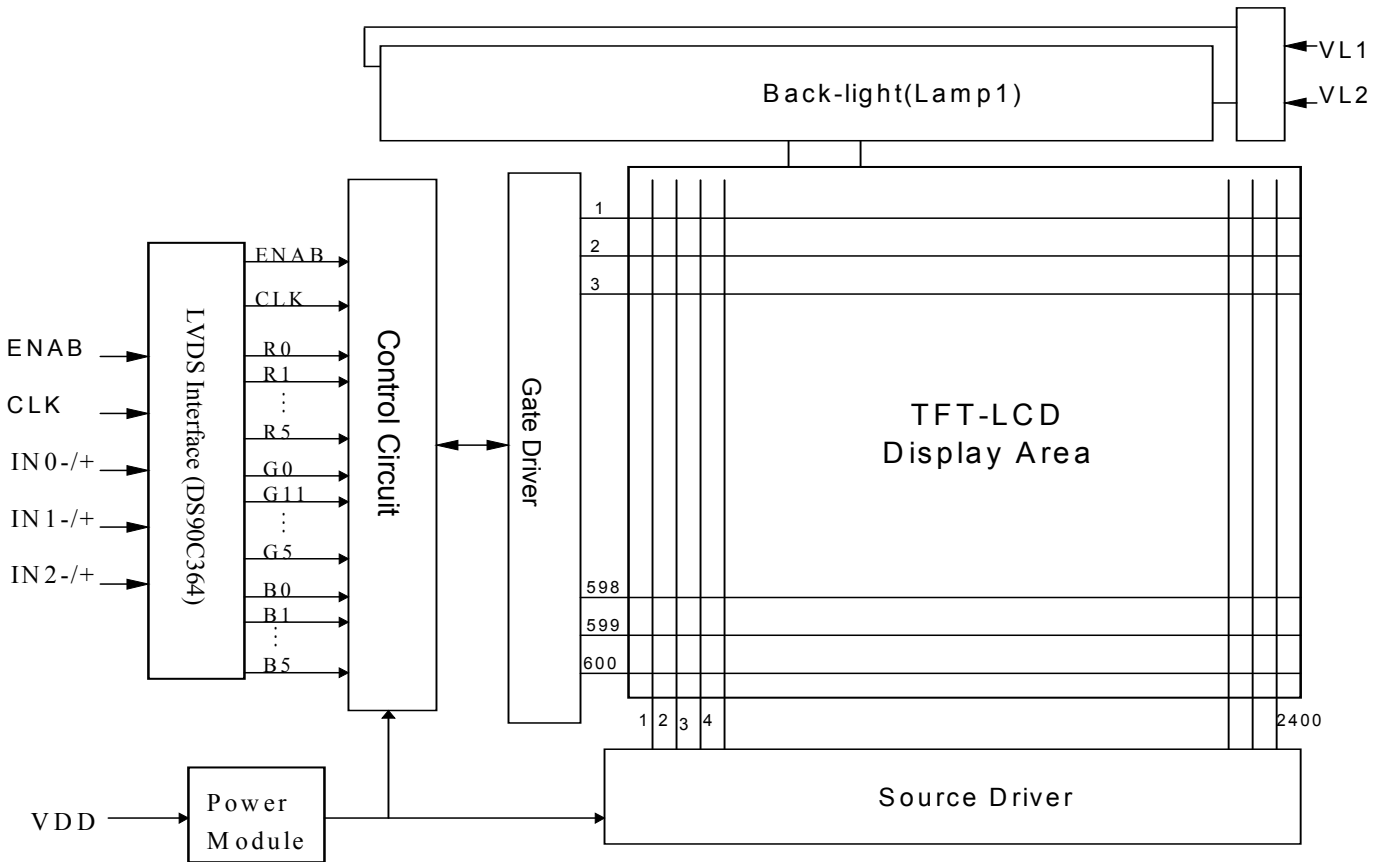

### 13.)Packing

ZONE	REV.	DOCUMENT NO.	DESCRIPTION	DATE	REV.BY																									
<p><b>NOTE:</b></p> <p>1.Q'TY: 20 pcs module/carton.                  2.Dimension: 530*295*230mm                  3.Weight: 9.0 Kg</p>																														
		<table border="1" style="width:100%; border-collapse: collapse;"> <thead> <tr> <th>ITEM</th> <th>PART NO.</th> <th>DESCRIPTION</th> <th>QTY</th> <th>REMARK</th> </tr> </thead> <tbody> <tr> <td>4</td> <td>50-0100111</td> <td>CARTON</td> <td>1</td> <td></td> </tr> <tr> <td>3</td> <td>50-0500061</td> <td>防靜電氣泡袋 Pink</td> <td>20</td> <td>抗靜電</td> </tr> <tr> <td>2</td> <td></td> <td>10.4"(薄) Module</td> <td>20</td> <td></td> </tr> <tr> <td>1</td> <td>50-0301101</td> <td>瓦楞隔板緩衝材</td> <td>1</td> <td>上蓋+底座</td> </tr> </tbody> </table>		ITEM	PART NO.	DESCRIPTION	QTY	REMARK	4	50-0100111	CARTON	1		3	50-0500061	防靜電氣泡袋 Pink	20	抗靜電	2		10.4"(薄) Module	20		1	50-0301101	瓦楞隔板緩衝材	1	上蓋+底座		
ITEM	PART NO.	DESCRIPTION	QTY	REMARK																										
4	50-0100111	CARTON	1																											
3	50-0500061	防靜電氣泡袋 Pink	20	抗靜電																										
2		10.4"(薄) Module	20																											
1	50-0301101	瓦楞隔板緩衝材	1	上蓋+底座																										
MTL.SPEC.		UNSPECIFIED TOL'S		REMARK																										
		ANGLE																												
		ROUGHNESS																												
APPROVE		SCALE	UNIT	SHEET	DWG.TITLE																									
CHECK				1 OF 1	10.4" Packing																									
DRAWN	Patrick	'04.09.22	MTL.NO.	DWG FILE:	REV. 02																									
					A4 SIZE																									

